



**VAN OPSTAL**  
B e n e l u x

**Van Opstal & C° s.a.**

Boomsesteenweg 34, B- 2630 Aartselaar  
Tel.: 03- 887.40.48 • Fax: 03- 887.76.06  
E-mail: [info@vanopstal.be](mailto:info@vanopstal.be)  
[www.vanopstal.be](http://www.vanopstal.be)

**Van Opstal Nederland b.v.**

Minden 56, NL- 7327 AW Apeldoorn  
Tel.: 055- 543.03.33 • Fax: 055- 543.00.09  
E-mail: [info@vanopstal.nl](mailto:info@vanopstal.nl)  
[www.vanopstal.nl](http://www.vanopstal.nl)



## QUINCAILLERIE DÉCORATIVE

© Toute reproduction, même partielle,  
est interdite sans autorisation écrite de  
Van Opstal & C° s.a.

### Index

Accessoires .....	121
Boutons.....	43
Poignées.....	1
Poignées de la campagne Dauby.....	53
Poignées et charnières de porte.....	95
Profils poignées.....	77
Quincaillerie décorative divers.....	113

Notes



## POIGNÉES

## POIGNÉES T

**Poignée en T en inox: perçage multiple de 32 mm**

- inox massif
- fixation: 2 x M4
- \* avec 3 pieds (3 x M4)

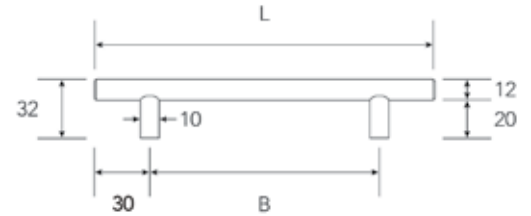

N° de com.	Finition	E	L	H	h	L	
060467	inox	64 mm	124 mm	32 mm	20 mm	12 mm	1 pièce
060468	inox	96 mm	156 mm	32 mm	20 mm	12 mm	1 pièce
060469	inox	128 mm	188 mm	32 mm	20 mm	12 mm	1 pièce
060470	inox	160 mm	220 mm	32 mm	20 mm	12 mm	1 pièce
060471	inox	192 mm	252 mm	32 mm	20 mm	12 mm	1 pièce
060472	inox	224 mm	284 mm	32 mm	20 mm	12 mm	1 pièce
060473	inox	256 mm	316 mm	32 mm	20 mm	12 mm	1 pièce
060474	inox	288 mm	348 mm	32 mm	20 mm	12 mm	1 pièce
060475	inox	320 mm	380 mm	32 mm	20 mm	12 mm	1 pièce
060476	inox	352 mm	412 mm	32 mm	20 mm	12 mm	1 pièce
060477	inox	384 mm	444 mm	32 mm	20 mm	12 mm	1 pièce
060478	inox	448 mm	508 mm	32 mm	20 mm	12 mm	1 pièce
060479	inox	480 mm	540 mm	32 mm	20 mm	12 mm	1 pièce
060480	inox	544 mm	604 mm	32 mm	20 mm	12 mm	1 pièce
060481	inox	640 mm	700 mm	32 mm	20 mm	12 mm	1 pièce
060482	inox	672 mm	732 mm	32 mm	20 mm	12 mm	1 pièce
060483	inox	736 mm	796 mm	32 mm	20 mm	12 mm	1 pièce
060484	inox	* 960 mm	1020 mm	32 mm	20 mm	12 mm	1 pièce
060485	inox	* 1280 mm	1340 mm	32 mm	20 mm	12 mm	1 pièce
060486	inox	* 1440 mm	1500 mm	32 mm	20 mm	12 mm	1 pièce



### Poignée en T en inox: avec dimensions fixes comparées à la largeur de la façade du tiroir

- inox massif
- fixation: 2 x M4

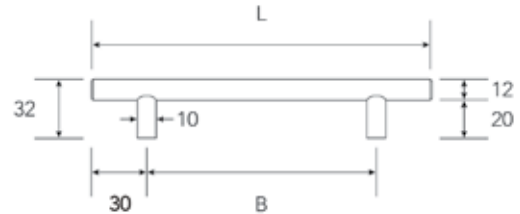

ex. armoire avec largeur 400 mm

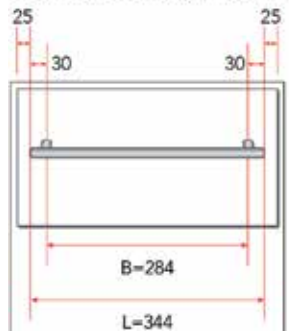

ex. armoire avec largeur 600 mm

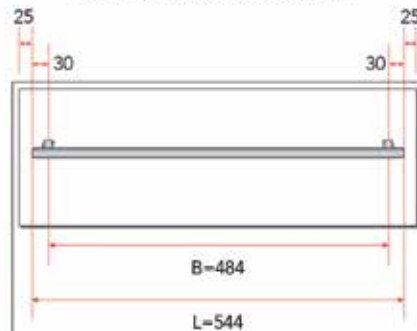

N° de com.	Finition / largeur armoire	E	L	H	h	L	
060490	inox / 300 mm	184 mm	244 mm	32 mm	20 mm	12 mm	1 pièce
060491	inox / 350 mm	234 mm	294 mm	32 mm	20 mm	12 mm	1 pièce
060492	inox / 400 mm	284 mm	344 mm	32 mm	20 mm	12 mm	1 pièce
060493	inox / 450 mm	334 mm	394 mm	32 mm	20 mm	12 mm	1 pièce
060494	inox / 500 mm	384 mm	444 mm	32 mm	20 mm	12 mm	1 pièce
060495	inox / 550 mm	434 mm	494 mm	32 mm	20 mm	12 mm	1 pièce
060496	inox / 600 mm	484 mm	544 mm	32 mm	20 mm	12 mm	1 pièce
060497	inox / 700 mm	584 mm	644 mm	32 mm	20 mm	12 mm	1 pièce
060498	inox / 800 mm	684 mm	744 mm	32 mm	20 mm	12 mm	1 pièce
060499	inox / 900 mm	784 mm	844 mm	32 mm	20 mm	12 mm	1 pièce
060500	inox / 1000 mm	884 mm	944 mm	32 mm	20 mm	12 mm	1 pièce
060501	inox / 1200 mm	1084 mm	1144 mm	32 mm	20 mm	12 mm	1 pièce



### Poignée en T en inox: pour montage vertical sur la façade d'une armoire de frigo

- inox massif
- avec 3 pieds
- fixation: 3 x M4

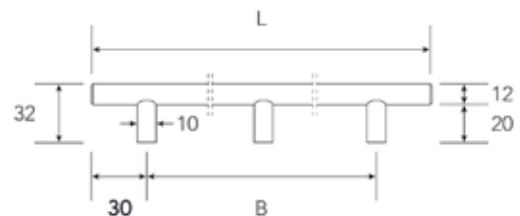







N° de com.	Finition / hauteur armoire	E	L	H	h	L	
060502	inox / 1100 mm	924 mm	984 mm	32 mm	20 mm	12 mm	1 pièce
060503	inox / 1300 mm	1092 mm	1152 mm	32 mm	20 mm	12 mm	1 pièce

**Poignée en T en inox type T12**

- matière première: inox AISI 304

- fixation: 2 x M4

N° de com.	Finition	 E	 L	 H	 h	 L	
016101	noir mat	96 mm	156 mm	32 mm	20 mm	12 mm	1 pièce
016102	noir mat	128 mm	188 mm	32 mm	20 mm	12 mm	1 pièce
016103	noir mat	160 mm	220 mm	32 mm	20 mm	12 mm	1 pièce
016104	noir mat	192 mm	252 mm	32 mm	20 mm	12 mm	1 pièce
016105	noir mat	224 mm	284 mm	32 mm	20 mm	12 mm	1 pièce

POIGNÉES COURBÉES



**Poignée courbée en inox U**

- fixation: 2 x M4

N° de com.	Finition	E	L	H	h	L	
058170	inox brossée	64 mm	74 mm	35 mm	25 mm	10 mm	1 pièce
058171	inox brossée	96 mm	106 mm	35 mm	25 mm	10 mm	1 pièce
058172	inox brossée	128 mm	138 mm	35 mm	25 mm	10 mm	1 pièce
058173	inox brossée	160 mm	170 mm	35 mm	25 mm	10 mm	1 pièce
058174	inox brossée	192 mm	202 mm	35 mm	25 mm	10 mm	1 pièce



**Poignée courbée en inox type I1021**

- fixation: 2 x M4

N° de com.	Finition	E	L	H	h	L	
058291	inox brossée	96 mm	108 mm	35 mm	23 mm	12 mm	1 pièce
058292	inox brossée	128 mm	139 mm	35 mm	23 mm	12 mm	1 pièce
058293	inox brossée	160 mm	172 mm	35 mm	23 mm	12 mm	1 pièce
058294	inox brossée	192 mm	204 mm	35 mm	23 mm	12 mm	1 pièce

**Poignée courbée en inox type I1020**

- fixation: 2 x M4

N° de com.	Finition	E	L	H	h	L	
058241	inox brossée	96 mm	118 mm	34 mm	22 mm	12 mm	1 pièce
058242	inox brossée	128 mm	150 mm	34 mm	22 mm	12 mm	1 pièce
058243	inox brossée	160 mm	182 mm	34 mm	22 mm	12 mm	1 pièce
058244	inox brossée	192 mm	214 mm	34 mm	22 mm	12 mm	1 pièce

**Poignée courbée en acier type 15.022.35**

- fixation: 2 x M4

N° de com.	Finition	E	L	H	h	L	
058661	nickelée mat	96 mm	104 mm	29 mm	21 mm	8 mm	1 pièce

**Poignée courbée en zamac type Phantom**

- fixation: 2 x M4

N° de com.	Finition	E	L	H	h	L	
058651	chromé mat	128 mm	145 mm	35 mm	14 mm	10 mm	1 pièce
058653	chromé mat	192 mm	208 mm	35 mm	14 mm	10 mm	1 pièce
058652	inox look	128 mm	145 mm	35 mm	14 mm	10 mm	1 pièce
058654	inox look	192 mm	208 mm	35 mm	14 mm	10 mm	1 pièce

**Poignée courbée en zamac type 1351**

- fixation: 2 x M4

N° de com.	Finition	E	L	H	h	L	
058974	chromé brillant	320 mm	345 mm	28 mm	20 mm	9 mm	1 pièce



**Poignée courbée en zamac type 7531**

- fixation: 2 x M4



N° de com.	Finition	E	L	H	h	L	
058877	chromé	96 mm	124 mm	30 mm	16 mm	8 mm	1 pièce
058878	chromé mat	96 mm	124 mm	30 mm	16 mm	8 mm	1 pièce
058876	inox look	96 mm	124 mm	30 mm	16 mm	8 mm	1 pièce
058745	chromé	160 mm	188 mm	35 mm	-	9 mm	1 pièce
058746	chromé look	160 mm	188 mm	35 mm	-	9 mm	1 pièce
058744	inox look	160 mm	188 mm	35 mm	-	9 mm	1 pièce



**Poignée courbée en zamac type**

**7691/7692/7693/7694**

- fixation: 2 x M4



N° de com.	Finition	E	L	H	h	L	
058903	inox look	16 mm	26 mm	26 mm	17 mm	10 mm	1 pièce
058900	inox look	128 mm	137 mm	26 mm	17 mm	10 mm	1 pièce
058899	chromé mat	160 mm	169 mm	26 mm	17 mm	10 mm	1 pièce
058897	inox look	160 mm	169 mm	26 mm	17 mm	10 mm	1 pièce
058895	chromé	192 mm	200 mm	26 mm	17 mm	10 mm	1 pièce
058896	chromé mat	192 mm	200 mm	26 mm	17 mm	10 mm	1 pièce
058894	inox look	192 mm	200 mm	26 mm	17 mm	10 mm	1 pièce



**Poignée courbée en zamac type 7461/7462**

- fixation: 2 x M4



N° de com.	Finition	E	L	H	h	L	
058871	chromé mat	128 mm	161 mm	24 mm	20 mm	19 mm	1 pièce
058868	chromé mat	160 mm	197 mm	24 mm	20 mm	21 mm	1 pièce



**Poignée courbée en zamac type i-spazio**

- fixation: 2 x M4

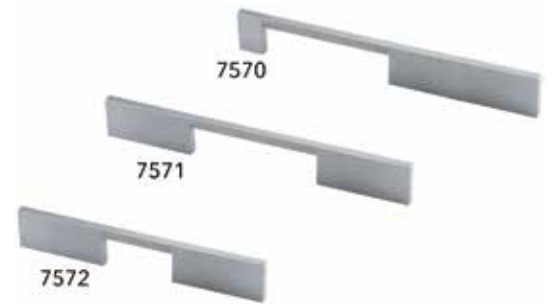







N° de com.	Finition	E	L	H	h	L	
058882	type 7572 - inox look	128 mm	200 mm	32 mm	22 mm	8 mm	1 pièce
058879	type 7571 - inox look	192 mm	260 mm	32 mm	22 mm	8 mm	1 pièce
059418	type 7570 - inox look	192 mm	260 mm	32 mm	22 mm	8 mm	1 pièce



**Poignée courbée en zamac type Cubic**

- fixation: 2 x M4









N° de com.	Finition						
059431	chromé mat	32 mm	55 mm	20 mm	-	10 mm	1 pièce
059430	inox look	32 mm	55 mm	20 mm	-	10 mm	1 pièce
059429	chromé mat	64 mm	85 mm	20 mm	-	11 mm	1 pièce
059428	inox look	64 mm	85 mm	20 mm	-	11 mm	1 pièce
059427	chromé mat	96 mm	115 mm	20 mm	-	12 mm	1 pièce
059426	inox look	96 mm	115 mm	20 mm	-	12 mm	1 pièce



**Poignée courbée en zamac type 7291/7292**

- fixation: 2 x M4



N° de com.	Finition						
059441	chromé	32 mm	48 mm	20 mm	-	12 mm	1 pièce
059440	inox look	32 mm	48 mm	20 mm	-	12 mm	1 pièce
059438	inox look	64 mm	81 mm	20 mm	-	12 mm	1 pièce



**Poignée en zamac type 3320**

- fixation: 2 x M4
- adapté pour entraxe 64, 96 et 128 mm

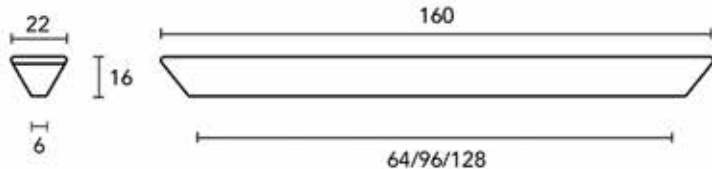

N° de com.	Finition	-	Unité de com.
059545	nickelée mat	-	1 pièce

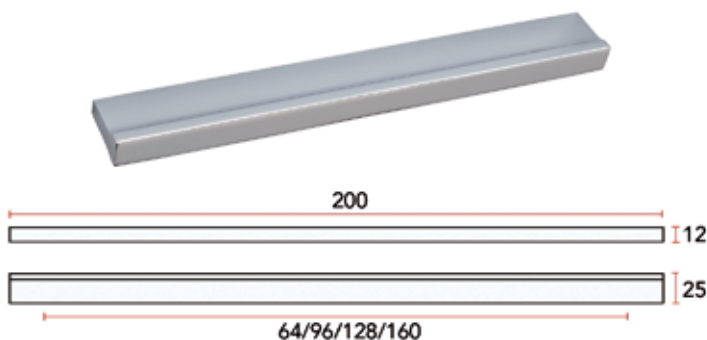

**Poignée en zamac type 3990**

- fixation: 2 x M4
- adapté pour entraxe 64, 96, 128 et 160 mm

N° de com.	Finition	-	Unité de com.
059548	nickelée mat	-	1 pièce



**Poignée courbée en zamac type 1431**

- fixation: 2 x M4







N° de com.	Finition	E	L	H	h	L	
058967	inox look/chromé	160 mm	167 mm	29 mm	23 mm	27 mm	1 pièce



**Poignée courbée type URG12**

- matière première: inox AISI 304

- fixation: 2 x M4





N° de com.	Finition	 E	 L	 H	 h	 L	
016106	noir mat	96 mm	108 mm	36 mm	24 mm	12 mm	1 pièce
016107	noir mat	128 mm	140 mm	36 mm	24 mm	12 mm	1 pièce
016108	noir mat	160 mm	172 mm	36 mm	24 mm	12 mm	1 pièce
016109	noir mat	192 mm	204 mm	36 mm	24 mm	12 mm	1 pièce
016110	noir mat	285 mm	297 mm	36 mm	24 mm	12 mm	1 pièce



**Bouton en inox type D12**

- matière première: inox AISI 304

- fixation: 1 x M4





N° de com.	Finition	 Ø	 Ø	 H	 h	-	
016921	bronze mat	12 mm	12 mm	26 mm	-	-	1 pièce
016092	noir mat	12 mm	12 mm	26 mm	-	-	1 pièce



**Bouton en inox type D20**

- matière première: inox AISI 304

- fixation: 1 x M4

N° de com.	Finition	 Ø	 Ø	 H	 h	-	
016922	bronze mat	20 mm	20 mm	26 mm	-	-	1 pièce
016990	noir mat	20 mm	20 mm	26 mm	-	-	1 pièce

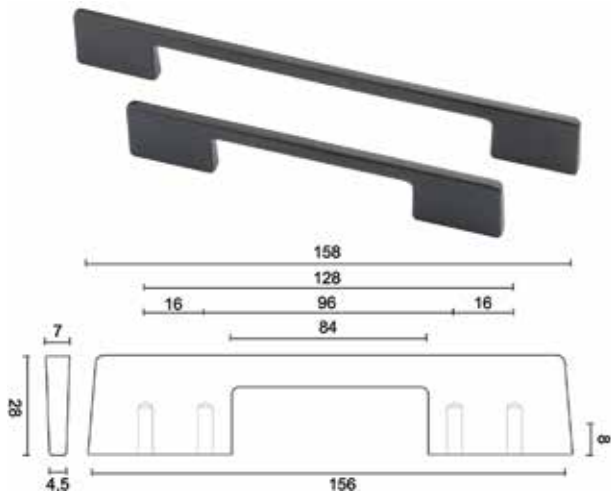

**Poignée courbée en inox type Seliz**

- matière première: inox AISI 304
- fixation: 4 x M4
- 2 x 2 points de fixation

N° de com.	Finition	E	L	H	h	L	
016895	noir mat	96/128 mm	156 mm	28 mm	20 mm	7 mm	1 pièce
016896	noir mat	160/192 mm	220 mm	28 mm	20 mm	7 mm	1 pièce



**Bouton en inox type Seliz**

- matière première: inox AISI 304
- fixation: 2 x M4

N° de com.	Finition	E	L	H	h	L	
016897	noir mat	20 mm	37 mm	28 mm	-	7 mm	1 pièce



**Poignée courbée en inox type Cubica 10**

- matière première: inox AISI 304
- fixation: 2 x M4

N° de com.	Finition	E	L	H	h	L	
016086	noir mat	96 mm	106 mm	35 mm	25 mm	10 mm	1 pièce
016087	noir mat	128 mm	138 mm	35 mm	25 mm	10 mm	1 pièce
016088	noir mat	160 mm	170 mm	35 mm	25 mm	10 mm	1 pièce
016089	noir mat	192 mm	202 mm	35 mm	25 mm	10 mm	1 pièce
016090	noir mat	285 mm	295 mm	35 mm	25 mm	10 mm	1 pièce



**Poignée courbée en inox type Cubica 12**

- matière première: inox AISI 304
- fixation: 2 x M4

N° de com.	Finition	E	L	H	h	L	
016914	bronze mat	96 mm	108 mm	35 mm	23 mm	12 mm	1 pièce
016915	bronze mat	128 mm	140 mm	35 mm	23 mm	12 mm	1 pièce
016916	bronze mat	160 mm	172 mm	35 mm	23 mm	12 mm	1 pièce
016917	bronze mat	192 mm	204 mm	35 mm	23 mm	12 mm	1 pièce
016918	bronze mat	285 mm	297 mm	35 mm	23 mm	12 mm	1 pièce



**Bouton en inox type Cubica 12**

- matière première: inox AISI 304
- fixation: 1 x M4

N° de com.	Finition			H	h	-	
016919	bronze mat	12 mm	12 mm	25 mm	-	-	1 pièce
016091	noir mat	12 mm	12 mm	25 mm	-	-	1 pièce



**Bouton en inox type Cubica 20**

- matière première: inox AISI 304
- fixation: 1 x M4

N° de com.	Finition			H	h	-	
016920	bronze mat	20 mm	20 mm	25 mm	-	-	1 pièce
016981	noir mat	20 mm	20 mm	25 mm	-	-	1 pièce

**Poignée courbée en inox type Hashtag 12**

- matière première: inox AISI 304

- fixation: 2 x M4



N° de com.	Finition	E	L	H	h	L	
016903	noir mat	96 mm	108 mm	36 mm	24 mm	12 mm	1 pièce
016904	noir mat	128 mm	140 mm	36 mm	24 mm	12 mm	1 pièce
016905	noir mat	160 mm	172 mm	36 mm	24 mm	12 mm	1 pièce
016906	noir mat	192 mm	204 mm	36 mm	24 mm	12 mm	1 pièce
016907	noir mat	285 mm	297 mm	36 mm	24 mm	12 mm	1 pièce

**Bouton en inox type Hashtag**

- matière première: inox AISI 304

- fixation: 1 x M4

N° de com.	Finition			H	h	-	
016908	noir mat	-	20 mm	25 mm	5 mm	-	1 pièce

**Poignée courbée en acier type 8534260**

- fixation: 2 x M4

N° de com.	Finition	E	L	H	h	L	
060905	noir mat laqué	160 mm	182 mm	38 mm	28 mm	10 mm	1 pièce
060906	noir mat laqué	320 mm	342 mm	38 mm	28 mm	10 mm	1 pièce
060907	noir mat laqué	512 mm	534 mm	38 mm	28 mm	10 mm	1 pièce



**Poignée courbée en zamac type Recife**

- fixation: 2 x M4

N° de com.	Finition	E	L	H	h	L	
<b>059512</b>	nickelée mat	224 mm	233 mm	28 mm	19 mm	20 mm	1 pièce
<b>059513</b>	nickelée mat	320 mm	329 mm	28 mm	19 mm	20 mm	1 pièce



**Poignée courbée en zamac type Rio**

- fixation: 2 x M4

N° de com.	Finition	E	L	H	h	L	
<b>059515</b>	nickelée brillant	256 mm	274 mm	39 mm	25 mm	13 mm	1 pièce



**Poignée courbée en zamac type Pronto**

- fixation: 2 x M4

- noir mat: RAL9005

N° de com.	Finition	E	L	H	h	L	
<b>059525</b>	nickelée mat	128 mm	134 mm	30 mm	27 mm	10 mm	1 pièce
<b>059527</b>	nickelée mat	160 mm	166 mm	30 mm	27 mm	10 mm	1 pièce
<b>059524</b>	noir mat	128 mm	134 mm	30 mm	27 mm	10 mm	1 pièce
<b>059526</b>	noir mat	160 mm	166 mm	30 mm	27 mm	10 mm	1 pièce

**Poignée courbée en zamac type Stretch**

- fixation: 2 x M4
- noir mat: RAL9005

N° de com.	Finition	E	L	H	h	L	
059990	inox look	96 mm	104 mm	28 mm	19 mm	8 mm	1 pièce
059519	inox look	160 mm	168 mm	28 mm	19 mm	8 mm	1 pièce
059992	inox look	224 mm	232 mm	28 mm	19 mm	8 mm	1 pièce
059521	inox look	320 mm	328 mm	28 mm	19 mm	8 mm	1 pièce
059989	noir mat	96 mm	104 mm	28 mm	19 mm	8 mm	1 pièce
059518	noir mat	160 mm	168 mm	28 mm	19 mm	8 mm	1 pièce
059991	noir mat	224 mm	232 mm	28 mm	19 mm	8 mm	1 pièce
059520	noir mat	320 mm	328 mm	28 mm	19 mm	8 mm	1 pièce

**Poignée courbée en zamac type Scoop**





- fixation: 2 x M4

N° de com.	Finition	E	L	H	h	L	
059987	noir antique	160 mm	180 mm	26 mm	19 mm	15 mm	1 pièce
059988	noir antique	320 mm	340 mm	26 mm	19 mm	15 mm	1 pièce
059533	nickelée mat	160 mm	180 mm	26 mm	19 mm	15 mm	1 pièce
059534	nickelée mat	320 mm	340 mm	26 mm	19 mm	15 mm	1 pièce



**Poignée courbée en zamac type Align**

- fixation: 2 x M4

N° de com.	Finition	 E	 L	 H	 h	 L	
059471	chromé mat	128 mm	157 mm	20 mm	15 mm	9 mm	1 pièce
059467	chromé mat	192 mm	208 mm	20 mm	15 mm	9 mm	1 pièce
059463	chromé mat	224 mm	252 mm	20 mm	15 mm	9 mm	1 pièce
059470	inox look	128 mm	157 mm	20 mm	15 mm	9 mm	1 pièce
059466	inox look	192 mm	208 mm	20 mm	15 mm	9 mm	1 pièce
059462	inox look	224 mm	252 mm	20 mm	15 mm	9 mm	1 pièce
059473	blanc mat	128 mm	157 mm	20 mm	15 mm	9 mm	1 pièce
059469	blanc mat	192 mm	208 mm	20 mm	15 mm	9 mm	1 pièce
059465	blanc mat	224 mm	252 mm	20 mm	15 mm	9 mm	1 pièce
059472	noir mat	128 mm	157 mm	20 mm	15 mm	9 mm	1 pièce
059468	noir mat	192 mm	208 mm	20 mm	15 mm	9 mm	1 pièce
059464	noir mat	224 mm	252 mm	20 mm	15 mm	9 mm	1 pièce



**Poignée courbée en zamac type  
6761/6762/6763/6764/6765**

- fixation: 2 x M4



N° de com.	Finition	E	L	H	h	L	
059164	chromé mat	128 mm	136 mm	28 mm	20 mm	8 mm	1 pièce
059162	chromé mat	160 mm	168 mm	28 mm	20 mm	8 mm	1 pièce
059160	chromé mat	192 mm	200 mm	28 mm	20 mm	8 mm	1 pièce
059158	chromé mat	256 mm	264 mm	28 mm	20 mm	8 mm	1 pièce
059156	chromé mat	320 mm	328 mm	28 mm	20 mm	8 mm	1 pièce
060392	or mat	128 mm	136 mm	28 mm	20 mm	8 mm	1 pièce
060391	or mat	192 mm	200 mm	28 mm	20 mm	8 mm	1 pièce
060390	or mat	320 mm	328 mm	28 mm	20 mm	8 mm	1 pièce
060401	graphite	128 mm	136 mm	28 mm	20 mm	8 mm	1 pièce
060400	graphite	192 mm	200 mm	28 mm	20 mm	8 mm	1 pièce
060399	graphite	320 mm	328 mm	28 mm	20 mm	8 mm	1 pièce
059163	inox look	128 mm	136 mm	28 mm	20 mm	8 mm	1 pièce
059161	inox look	160 mm	168 mm	28 mm	20 mm	8 mm	1 pièce
059159	inox look	192 mm	200 mm	28 mm	20 mm	8 mm	1 pièce
059157	inox look	256 mm	264 mm	28 mm	20 mm	8 mm	1 pièce
059155	inox look	320 mm	328 mm	28 mm	20 mm	8 mm	1 pièce
059050	noir mat	128 mm	136 mm	28 mm	20 mm	8 mm	1 pièce
059051	noir mat	160 mm	168 mm	28 mm	20 mm	8 mm	1 pièce
059052	noir mat	192 mm	200 mm	28 mm	20 mm	8 mm	1 pièce
059053	noir mat	256 mm	264 mm	28 mm	20 mm	8 mm	1 pièce
059054	noir mat	320 mm	328 mm	28 mm	20 mm	8 mm	1 pièce



**Poignée courbée en zamac type Square**

- fixation: 2 x M4



N° de com.	Finition	E	L	H	h	L	
059436	inox look	64 mm	81 mm	29 mm	18 mm	10 mm	1 pièce
059434	inox look	96 mm	114 mm	30 mm	18 mm	11 mm	1 pièce



**Poignée courbée en zamac type 1327**

- fixation: 2 x M4

N° de com.	Finition	E	L	H	h	L	
058966	inox look	160 mm	168 mm	28 mm	20 mm	9 mm	1 pièce



**Poignée courbée en zamac type 17811**

- fixation: 2 x M4

N° de com.	Finition	E	L	H	h	L	
059140	soudé	160 mm	175 mm	45 mm	30 mm	15 mm	1 pièce



**Poignée courbée en acier type 17812**

- fixation: 2 x M4

N° de com.	Finition	E	L	H	h	L	
059141	acier bleu	160 mm	190 mm	60 mm	32 mm	20 mm	1 pièce
059142	acier bleu	320 mm	350 mm	60 mm	32 mm	20 mm	1 pièce



**Poignée courbée en PVC type 48.0090**

- fixation: 2 x vis à bois Ø 3,5 mm

N° de com.	Finition	E	L	H	h	L	
055101	blanc	96 mm	106 mm	30 mm	20 mm	10 mm	1 pièce

## POIGNÉES EN DEMI-CERCLE

**Poignée en demi-cercle en inox type I0003**

- fixation: 2 x M4

N° de com.	Finition	E	L	H	h	L	
058207	inox brossée	96 mm	115 mm	32 mm	22 mm	10 mm	1 pièce
058208	inox brossée	128 mm	152 mm	32 mm	22 mm	10 mm	1 pièce
058209	inox brossée	160 mm	187 mm	32 mm	22 mm	10 mm	1 pièce
058210	inox brossée	192 mm	224 mm	32 mm	22 mm	10 mm	1 pièce

**Poignée en demi-cercle en inox type A10450**

- fixation: 2 x M4

N° de com.	Finition	E	L	H	h	L	
058323	inox brossée	160 mm	183 mm	35 mm	25 mm	10 mm	1 pièce

**Poignée en demi-cercle en acier type 78.xxxx.36**

- chromé mat

- fixation: 2 x M4

N° de com.	Finition	E	L	H	h	L	
058667	chromé mat	96 mm	110 mm	28 mm	18 mm	10 mm	1 pièce
058668	chromé mat	128 mm	146 mm	28 mm	18 mm	10 mm	1 pièce

**Poignée en demi-cercle en acier type 78.xxxx.49**

- nickelé mat

- fixation: 2 x M4

- 96 mm et 128 mm en zamac.

N° de com.	Finition	E	L	H	h	L	
058672	inox look	96 mm	110 mm	28 mm	18 mm	10 mm	1 pièce
058673	inox look	128 mm	146 mm	28 mm	18 mm	10 mm	1 pièce
058674	inox look	160 mm	194 mm	28 mm	18 mm	10 mm	1 pièce
058675	inox look	192 mm	202 mm	28 mm	18 mm	10 mm	1 pièce



**Poignée en demi-cercle en zamac type Swoosh**

- fixation: 2 x M4

N° de com.	Finition	E	L	H	h	L	
059536	nickelée mat	320 mm	360 mm	32 mm	21 mm	11 mm	1 pièce



**Poignée en demi-cercle en zamac type Bravo**

- fixation: 2 x M4

N° de com.	Finition	E	L	H	h	L	
058655	chromé mat	128 mm	142 mm	25 mm	17 mm	14 mm	1 pièce



**Poignée en demi-cercle en zamac type 1340**

- fixation: 2 x M4

N° de com.	Finition	E	L	H	h	L	
058969	inox look	160 mm	172 mm	34 mm	26 mm	9 mm	1 pièce



**Poignée en demi-cercle en zamac type Genova**

- fixation: 2 x M4

N° de com.	Finition	E	L	H	h	L	
059522	nickelée brillant	160 mm	226 mm	31 mm	20 mm	20 mm	1 pièce
059523	nickelée brillant	224 mm	290 mm	31 mm	20 mm	20 mm	1 pièce



**Poignée en demi-cercle en zamac type Arch**  
- fixation: 2 x M4



N° de com.	Finition	E	L	H	h	L	
059416	chromé mat	128 mm	240 mm	18 mm	16 mm	20 mm	1 pièce
059415	inox look	128 mm	240 mm	18 mm	16 mm	20 mm	1 pièce
059414	chromé mat	192 mm	320 mm	18 mm	16 mm	20 mm	1 pièce
059413	inox look	192 mm	320 mm	18 mm	16 mm	20 mm	1 pièce



**Poignée en demi-cercle en zamac type Fluid**  
- fixation: 2 x M4



N° de com.	Finition	E	L	H	h	L	
059497	inox look	192/224 mm	236 mm	29 mm	-	13 mm	1 pièce
059494	inox look	288/320 mm	363 mm	34 mm	-	13 mm	1 pièce
059498	blanc mat	192/224 mm	236 mm	29 mm	-	13 mm	1 pièce
059495	blanc mat	288/320 mm	363 mm	34 mm	-	13 mm	1 pièce
059496	noir mat	192/224 mm	236 mm	29 mm	-	13 mm	1 pièce
059493	noir mat	288/320 mm	363 mm	34 mm	-	13 mm	1 pièce



**Poignée en demi-cercle en zamac type 7150**

- fixation: 2 x M4

N° de com.	Finition	E	L	H	h	L	
058865	chromé mat	96 mm	152 mm	27 mm	21 mm	20 mm	1 pièce
058863	inox look	96 mm	152 mm	27 mm	21 mm	20 mm	1 pièce



**Poignée en demi-cercle en zamac type Fuji 681**

- fixation: 2 x M4



N° de com.	Finition	E	L	H	h	L	
059487	chromé	160 mm	230 mm	32 mm	-	20 mm	1 pièce
060394	or mat	160 mm	230 mm	32 mm	26 mm	20 mm	1 pièce
060403	graphite	160 mm	230 mm	32 mm	26 mm	20 mm	1 pièce
059486	inox look	160 mm	230 mm	32 mm	-	20 mm	1 pièce
059484	chromé	224 mm	320 mm	32 mm	-	20 mm	1 pièce
060393	or mat	224 mm	320 mm	32 mm	26 mm	20 mm	1 pièce
060402	graphite	224 mm	320 mm	32 mm	26 mm	20 mm	1 pièce









**Poignée en demi-cercle en zamac type 7861/7862**

- fixation: 2 x M4

N° de com.	Finition	E	L	H	h	L	
059444	blanc brillant	96 mm	124 mm	29 mm	20 mm	9 mm	1 pièce
059442	blanc brillant	128 mm	164 mm	29 mm	20 mm	10 mm	1 pièce
059445	noir brillant	96 mm	124 mm	29 mm	20 mm	9 mm	1 pièce
059443	noir brillant	128 mm	164 mm	29 mm	20 mm	10 mm	1 pièce

**Poignée en zamac type 8010**







- fixation: 1 x M4

N° de com.	Finition						
<b>059446</b>	blanc brillant	12 mm	12 mm	28 mm	-	12 mm	1 pièce
<b>059447</b>	noir brillant	12 mm	12 mm	28 mm	-	12 mm	1 pièce

**Poignée en demi-cercle en laiton type 451**

- bronze antique

- fixation: 2 x M4

N° de com.	Finition						
<b>056810</b>	bronze antique	64 mm	100 mm	26 mm	20 mm	-	1 pièce

POIGNÉES ANGLE



SCREW-ON TRIM HANDLE



Poignée angle en zamac type Treme

- fixation: 2 x M4

N° de com.	Finition	E	L	H	h	L	
059531	nickelée mat	32 mm	56 mm	20 mm	-	36 mm	1 pièce
059530	nickelée mat	160 mm	200 mm	20 mm	-	36 mm	1 pièce



Poignée angle en zamac type 7661/7662/7663

- poignée type 7663: entraxe 32 mm
- poignée type 7662: entraxe 96 mm
- poignée type 7661: entraxe 192 mm

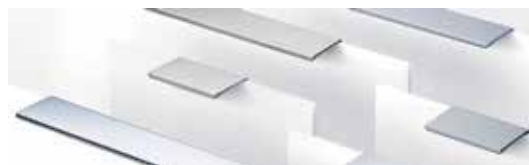





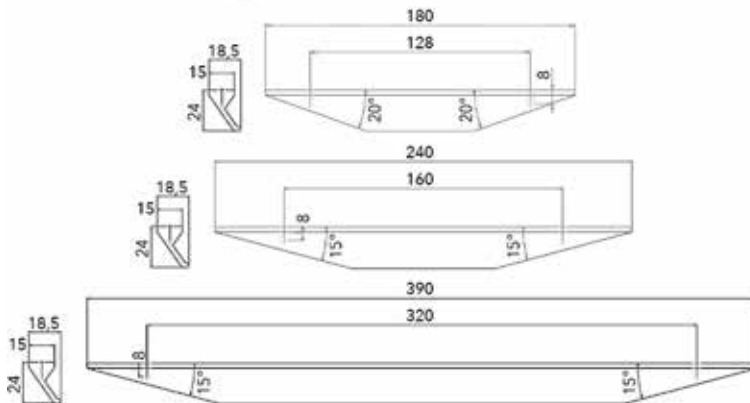

N° de com.	Finition	E	L	H	d	P	
058754	chromé	32 mm	71 mm	24 mm	2 mm	44 mm	1 pièce
058755	chromé mat	32 mm	71 mm	24 mm	2 mm	44 mm	1 pièce
058751	chromé	96 mm	135 mm	24 mm	2 mm	44 mm	1 pièce
058752	chromé mat	96 mm	135 mm	24 mm	2 mm	44 mm	1 pièce
058749	chromé mat	192 mm	231 mm	24 mm	2 mm	44 mm	1 pièce
058753	inox look	32 mm	71 mm	24 mm	2 mm	44 mm	1 pièce
058750	inox look	96 mm	135 mm	24 mm	2 mm	44 mm	1 pièce
058747	inox look	192 mm	231 mm	24 mm	2 mm	44 mm	1 pièce
059556	blanc mat	32 mm	71 mm	24 mm	2 mm	44 mm	1 pièce
059554	blanc mat	96 mm	135 mm	24 mm	2 mm	44 mm	1 pièce
059552	blanc mat	192 mm	231 mm	24 mm	2 mm	44 mm	1 pièce
059555	noir mat	32 mm	71 mm	24 mm	2 mm	44 mm	1 pièce
059553	noir mat	96 mm	135 mm	24 mm	2 mm	44 mm	1 pièce
058748	chromé	192 mm	231 mm	24 mm	2 mm	44 mm	1 pièce
059551	noir mat	192 mm	231 mm	24 mm	2 mm	44 mm	1 pièce







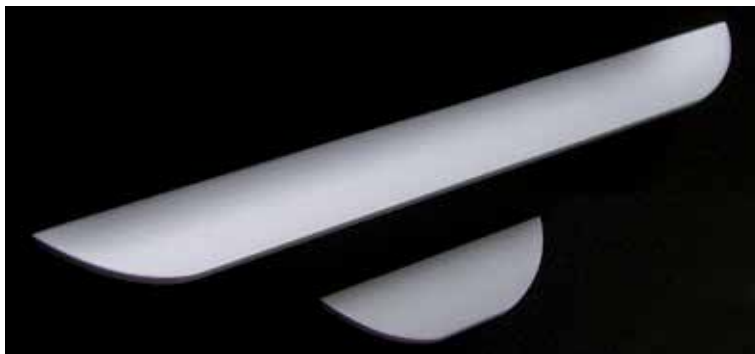

**Poignée angle en aluminium type AL26000**  
- fixation: 2 x M4



N° de com.	Finition	 E	 L	 H	 d	 P	
<b>060902</b>	noir mat brossé	128 mm	180 mm	15 mm	3 mm	24 mm	1 pièce
<b>060903</b>	noir mat brossé	160 mm	240 mm	15 mm	3 mm	24 mm	1 pièce
<b>060904</b>	noir mat brossé	320 mm	390 mm	15 mm	3 mm	24 mm	1 pièce



**Poignée angle en aluminium type Vienna**  
- fixation: 2 x M4







N° de com.	Finition	 E	 L	 H	 h	 L	
<b>058714</b>	alu mat	64 mm	114 mm	20 mm	-	24 mm	1 pièce
<b>058715</b>	alu mat	128 mm	220 mm	20 mm	-	24 mm	1 pièce
<b>058717</b>	alu mat	192 mm	320 mm	20 mm	-	24 mm	1 pièce



**Poignée angle en inox type Fine**

- matière première: inox AISI 304
- fixation:
  - longueur 38 /200 mm: 2 x vis à bois et aggloméré noir
  - longueur 400 mm: 4 x vis à bois et aggloméré noir









N° de com.	Finition	 E	 L	 H	 h	 P	
016898	noir mat	-	38 mm	20 mm	-	35 mm	1 pièce
016899	noir mat	-	100 mm	20 mm	-	35 mm	1 pièce
016900	noir mat	-	200 mm	20 mm	-	35 mm	1 pièce
016901	noir mat	-	400 mm	20 mm	-	35 mm	1 pièce

**Poignée angle en zamac type Linea**

- fixation: 2 x M4



N° de com.	Finition	 E	 L	 H	 h	 L	
058956	fer vieux	96 mm	140 mm	22 mm	-	28 mm	1 pièce

**Poignée angle en zamac type 3125**

- fixation: 2 x M4

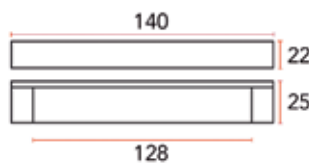

N° de com.	Finition	-	Unité de com.
059544	nickelée mat	-	1 pièce

POIGNÉES LONGUES



**Poignée longue type 3610**  
- fixation: 3 x M4

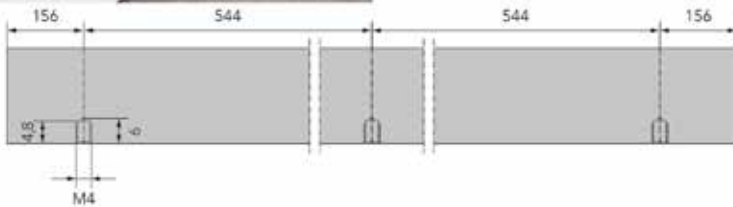
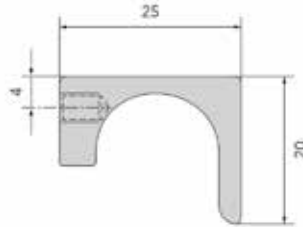

N° de com.	Finition	Longueur	Unité de com.
059319	inox look	1400 mm	1 pièce



**Poignée longue type 3659**  
- fixation: 2, 3 ou 4 x M4  
voir fiche technique

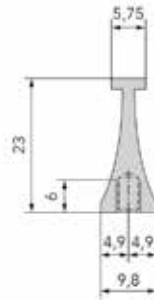

N° de com.	Finition	Longueur	Unité de com.
059622	noir anodisé	180 mm	1 pièce
059623	noir anodisé	410 mm	1 pièce
059624	noir anodisé	560 mm	1 pièce
059625	noir anodisé	760 mm	1 pièce
059626	noir anodisé	1160 mm	1 pièce
059318	noir anodisé	1400 mm	1 pièce

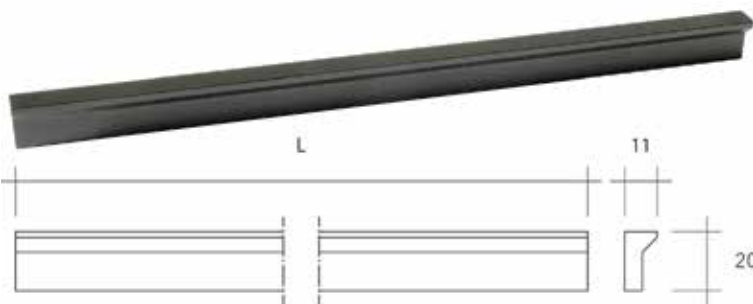

**Poignée longue type AL2326**

- matière première: aluminium
- fixation:
- longueur 447 mm: 2 x M4
- longueur 897 mm: 3 x M4

N° de com.	Finition	Longueur (L)	Unité de com.
060918	noir mat	447 mm	1 pièce
060917	noir mat	897 mm	1 pièce



**Poignée longue type 392**

- matière première: zamac
- fixation:
- longueur 246 mm: 2 x M4
- longueur 496 mm: 4 x M4
- longueur 1096 mm: 5 x M4

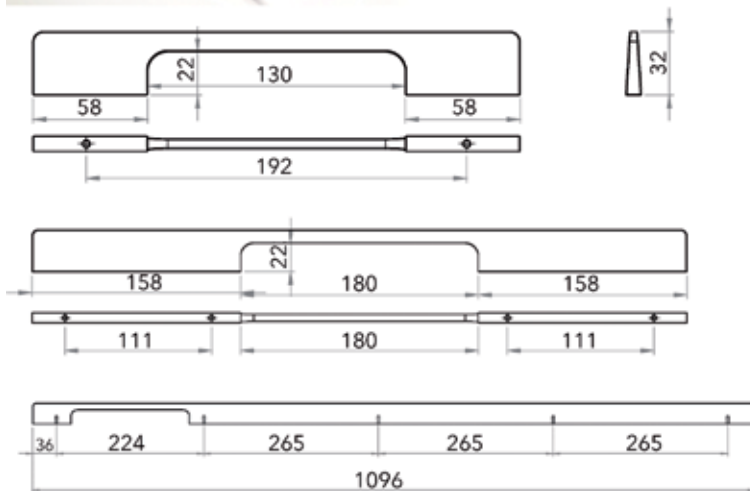

N° de com.	Finition	E	L	H	h	L	
039000	or mat	192 mm	246 mm	32 mm	22 mm	8 mm	1 pièce
039003	or mat	-	496 mm	32 mm	22 mm	8 mm	1 pièce
039204	or mat	-	1096 mm	32 mm	22 mm	8 mm	1 pièce
039001	blanc mat	192 mm	246 mm	32 mm	22 mm	8 mm	1 pièce
039004	blanc mat	-	496 mm	32 mm	22 mm	8 mm	1 pièce
039205	blanc mat	-	1096 mm	32 mm	22 mm	8 mm	1 pièce
039002	noir mat	192 mm	246 mm	32 mm	22 mm	8 mm	1 pièce
039005	noir mat	-	496 mm	32 mm	22 mm	8 mm	1 pièce
039200	noir mat	-	1096 mm	32 mm	22 mm	8 mm	1 pièce

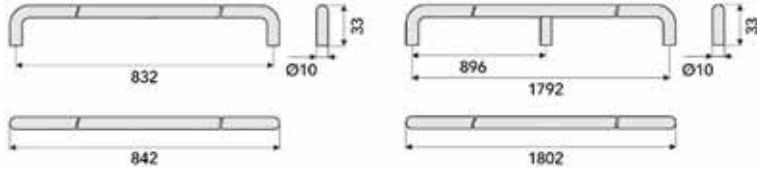

**Poignée longue type US10**

- matière première: acier
- fixation: 2 ou 3 x M4

- longueur 832 mm: 2 pieds
- longueur 1792 mm: 3 pieds

N° de com.	Finition	E	L	H	h	L	
059702	or mat	832 mm	842 mm	33 mm	23 mm	10 mm	1 pièce
059704	or mat	1792 mm	1802 mm	33 mm	23 mm	10 mm	1 pièce
059703	noir mat	832 mm	842 mm	33 mm	23 mm	10 mm	1 pièce
059705	noir mat	1792 mm	1802 mm	33 mm	23 mm	10 mm	1 pièce

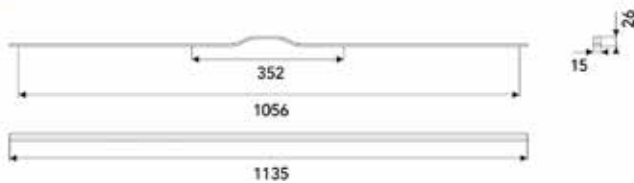

**Poignée longue type UA130**

- matière première: aluminium
- fixation: 4 x M4

N° de com.	Finition	E	L	H	h	L	
059707	or mat	352/1056 mm	1135 mm	26 mm	-	15 mm	1 pièce
059706	noir mat	352/1056 mm	1135 mm	26 mm	-	15 mm	1 pièce



**Poignée longue type UA131**

- matière première: aluminium

- fixation: 4 x M4

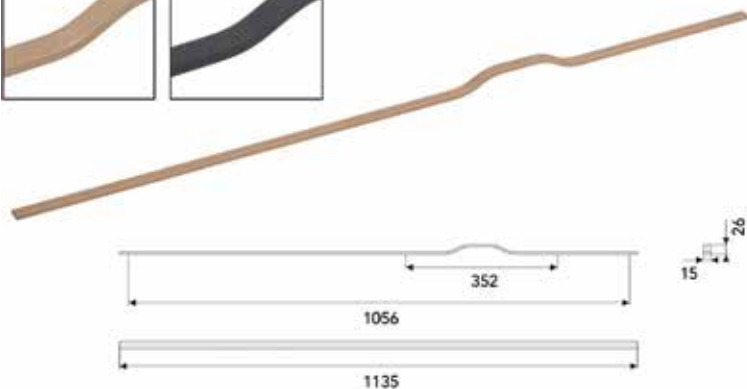

N° de com.	Finition	E	L	H	h	L	
059709	or mat	352/1056 mm	1135 mm	26 mm	-	15 mm	1 pièce
059708	noir mat	352/1056 mm	1135 mm	26 mm	-	15 mm	1 pièce

## CUVETTES ET POIGNÉES DE PORTES COULISSANTES



**Cuvette en zamac type 3510/3511**  
- profondeur d'encastrement: 11 mm

N° de com.	Finition	E	L	H	h	L	
058820	chromé mat	35 mm	40 mm	13 mm	11 mm	40 mm	1 pièce
058817	chromé mat	45 mm	49 mm	13 mm	11 mm	49 mm	1 pièce
058818	inox look	35 mm	40 mm	13 mm	11 mm	40 mm	1 pièce
058815	inox look	45 mm	49 mm	13 mm	11 mm	49 mm	1 pièce
059562	blanc mat	35 mm	40 mm	13 mm	11 mm	40 mm	1 pièce
059564	blanc mat	45 mm	49 mm	13 mm	11 mm	49 mm	1 pièce
059563	noir mat	35 mm	40 mm	13 mm	11 mm	40 mm	1 pièce
058816	chromé	45 mm	49 mm	13 mm	11 mm	49 mm	1 pièce
059565	noir mat	45 mm	49 mm	13 mm	11 mm	49 mm	1 pièce









**Cuvette en zamac type 353x**  
- profondeur d'encastrement: 11 mm

N° de com.	Finition	E	L	H	h	L	
059043	chromé mat	35 mm	40 mm	13 mm	10 mm	26 mm	1 pièce
059042	chromé mat	45 mm	49 mm	13 mm	10 mm	31 mm	1 pièce
059041	chromé mat	60 mm	65 mm	13 mm	10 mm	43 mm	1 pièce
059040	chromé mat	70 mm	75 mm	13 mm	10 mm	53 mm	1 pièce









**Cuvette en zamac type 3560/3561**  
- profondeur d'encastrement: 11 mm

N° de com.	Finition						
<b>058825</b>	chromé	35 mm	39 mm	13 mm	11 mm	39 mm	1 pièce
<b>058826</b>	chromé mat	35 mm	39 mm	13 mm	11 mm	39 mm	1 pièce
<b>058823</b>	chromé mat	45 mm	50 mm	13 mm	11 mm	50 mm	1 pièce



**Cuvette en zamac type 3710**

N° de com.	Finition						
<b>058757</b>	chromé	76 x 76 mm	80 mm	14 mm	-	80 mm	1 pièce
<b>058758</b>	chromé mat	76 x 76 mm	80 mm	14 mm	-	80 mm	1 pièce



**Cuvette en zamac type 3720**  
- profondeur d'encastrement: 16 mm

N° de com.	Finition	E	L	H	h	L	
058743	chromé mat	160 mm	180 mm	16 mm	-	50 mm	1 pièce
058742	inox look	160 mm	180 mm	16 mm	-	50 mm	1 pièce



**Cuvette en zamac type 3702/3703**  
- profondeur d'encastrement: 11 mm

N° de com.	Finition	E	L	H	h	L	
058831	chromé	78 mm	83 mm	13 mm	11 mm	36 mm	1 pièce
058832	chromé mat	78 mm	83 mm	13 mm	11 mm	36 mm	1 pièce
058829	chromé mat	110 mm	113 mm	14 mm	12 mm	42 mm	1 pièce
058830	inox look	78 mm	83 mm	13 mm	11 mm	36 mm	1 pièce
058827	inox look	110 mm	113 mm	14 mm	12 mm	42 mm	1 pièce
060901	blanc mat	110 mm	113 mm	14 mm	12 mm	42 mm	50 pièces



Cuvette en zamac type 3541/3542



N° de com.	Finition	E	L	H	L	L	
059049	inox look	145 mm	150 mm	10,7 mm	20 mm	25 mm	1 pièce
059048	inox look	235 mm	240 mm	10,7 mm	20 mm	25 mm	1 pièce



Cuvette en aluminium type 3730

- montage à l'intérieur de la porte
- profondeur d'encastrement: 16 mm
- fixation: 2 x M4



N° de com.	Finition	E	L	H	d	D	
058834	aluminium	170 mm	180 mm	25 mm	13 mm	18 mm	1 pièce



Cuvette en aluminium type 3740

- fixation: 2 x M4

N° de com.	Finition	E	L	H	d	D	
058835	aluminium	160 mm	180 mm	45 mm	12 mm	17 mm	1 pièce



Cuvette en zamac type MA20

N° de com.	Finition	-	Unité de com.
059550	nickelée mat	-	1 pièce



Cuvette en zamac type MA10

- fixation: 1 x M4

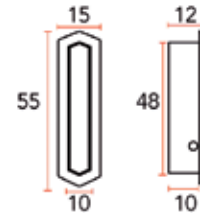

N° de com.	Finition	-	Unité de com.
059549	nickelée mat	-	1 pièce

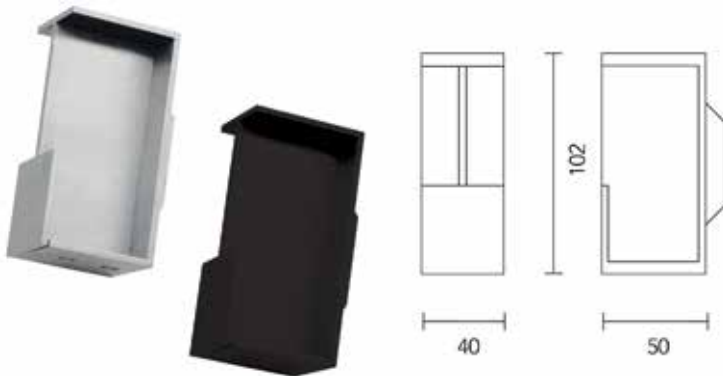

Poignée pour porte coulissante Carré massif

- matière première: inox AISI 304

N° de com.	Finition	Largeur	Profondeur	Hauteur	Unité de com.
016080	inox	40 mm	50 mm	102 mm	1 pièce
016081	noir mat	40 mm	50 mm	102 mm	1 pièce

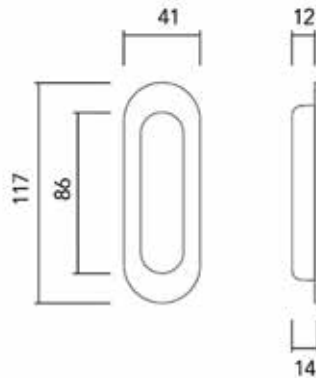

**Poignée pour porte coulissante Oval aveugle**

- matière première: inox AISI 304

N° de com.	Finition	-	Unité de com.
016082	inox	-	1 pièce
016083	noir mat	-	1 pièce

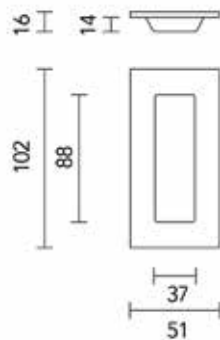

**Poignée pour porte coulissante Oval carré**

- matière première: inox AISI 304

N° de com.	Finition	-	Unité de com.
016084	inox	-	1 pièce
016085	noir mat	-	1 pièce

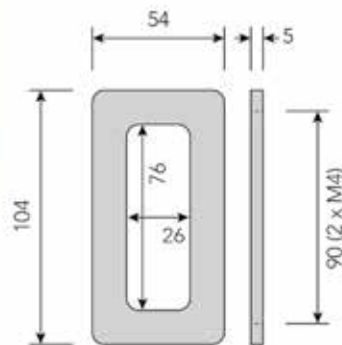

**Poignée pour portes coulissantes type 8899**

- avec une épaisseur réduite de seulement 5 mm  
 - à visser (2 x M4) ou à coller  
 (livré avec 2 bandes adhésives)

- entraxe: 90 mm

N° de com.	Finition	-	Unité de com.
014017	aluminium	-	1 pièce
014018	blanc	-	1 pièce
014019	noir mat	-	1 pièce

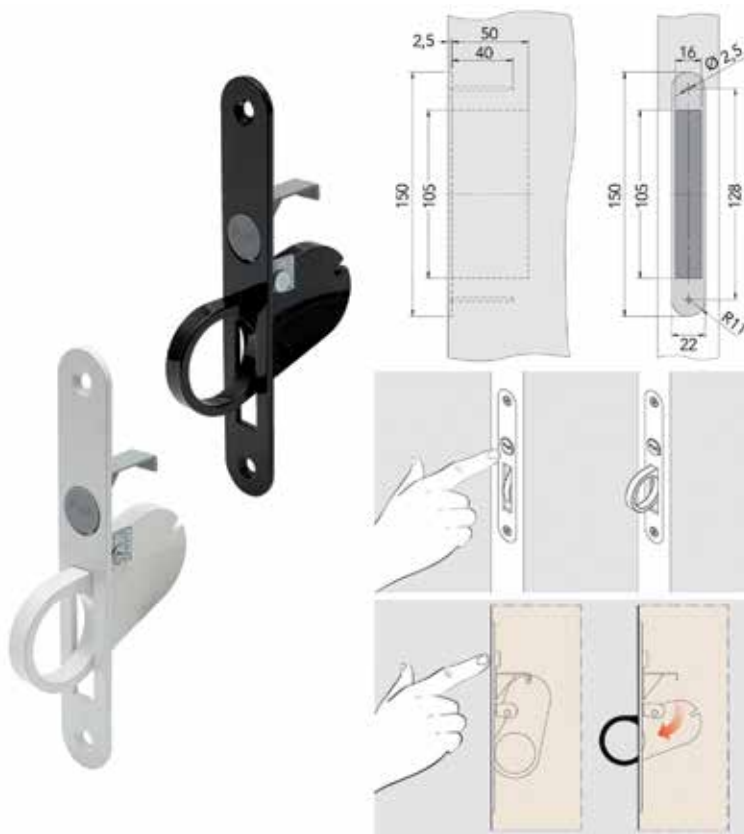

**Poignée push pour porte coulissante**

- poignée à encastrer: en appuyant sur le bouton, la poignée est éjectée







N° de com.	Finition	-	Unité de com.
014021	blanc (métal)	-	1 pièce
014022	noir (métal)	-	1 pièce

POIGNÉES COQUILLE



**Cuvette en laiton type Modern**







- matière première: laiton
- vis inclus

N° de com.	Finition						
016099	noir mat	63 mm	69 mm	33 mm	23 mm	14 mm	1 pièce



**Cuvette en laiton type Droite**







- matière première: laiton
- vis inclus

N° de com.	Finition						
016100	noir mat	90 mm	103 mm	42 mm	28 mm	21 mm	1 pièce



**Poignée en zamac type 70.1959**







- fixation: 2 x M4

N° de com.	Finition						
058690	bronze	64 mm	93 mm	20 mm	16 mm	28 mm	1 pièce
058689	inox look	64 mm	93 mm	20 mm	16 mm	28 mm	1 pièce



**Cuvette en zamac type Toronto**

- fixation: 2 x M4
- noir mat: RAL9005

N° de com.	Finition						
059529	nickelée brillant	96 mm	120 mm	26 mm	21 mm	30 mm	1 pièce
059528	noir mat	96 mm	120 mm	26 mm	21 mm	30 mm	1 pièce

**Cuvette en zamac type 6831/6832**

- fixation: 2 x M4



N° de com.	Finition	E	L	H	h	L	
060396	or mat	128 mm	149 mm	20 mm	18 mm	31 mm	1 pièce
060395	or mat	192 mm	213 mm	20 mm	18 mm	31 mm	1 pièce
060405	graphite	128 mm	149 mm	20 mm	18 mm	31 mm	1 pièce
060404	graphite	192 mm	213 mm	20 mm	18 mm	31 mm	1 pièce
060293	inox look	128 mm	149 mm	20 mm	18 mm	31 mm	1 pièce
060291	inox look	192 mm	213 mm	20 mm	18 mm	31 mm	1 pièce
060292	noir mat	128 mm	149 mm	20 mm	18 mm	31 mm	1 pièce
060290	noir mat	192 mm	213 mm	20 mm	18 mm	31 mm	1 pièce

**Cuvette en laiton à appliquer type 454**

- fixation: 2 x M4







N° de com.	Finition	E	L	H	h	L	
058530	antique (1)	64 mm	90 mm	40 mm	26 mm	-	1 pièce
056816	bronze antique (2)	64 mm	90 mm	40 mm	26 mm	-	1 pièce
058531	chromé (3)	64 mm	90 mm	40 mm	26 mm	-	20 pièces

RETRO



**Poignée en laiton type Petra**







- matière première: laiton  
- fixation: 2 x M4

N° de com.	Finition	 E	 L	 H	 h	 L	
016094	noir mat	96 mm	120 mm	35 mm	22 mm	9 mm	1 pièce
016095	noir mat	128 mm	152 mm	35 mm	22 mm	9 mm	1 pièce
016096	noir mat	160 mm	184 mm	35 mm	22 mm	9 mm	1 pièce
016097	noir mat	224 mm	248 mm	35 mm	22 mm	9 mm	1 pièce



**Bouton en laiton type Petra**







- matière première: laiton  
- fixation: 1 x M4

N° de com.	Finition	 T ∅	 L	 H	 h	 L	
016098	noir mat	17 mm	47 mm	35 mm	22 mm	17 mm	1 pièce



**Poignée en zamac type Sulky**

- fixation: 2 x M4

N° de com.	Finition	 E	 L	 H	 h	 L	
059502	fer vieilli mat	128 mm	154 mm	34 mm	23 mm	26 mm	1 pièce
059501	acier noir mat	128 mm	154 mm	34 mm	23 mm	26 mm	1 pièce



**Poignée en zamac type Halti**

- fixation: 2 x M4

N° de com.	Finition	E	L	H	h	L	
059509	acier noir mat	128 mm	158 mm	31 mm	27 mm	27 mm	1 pièce



**Poignée en zamac type Castle**

- fixation: 2 x M4

N° de com.	Finition	E	L	H	h	L	
059510	acier noir mat	160 mm	183 mm	36 mm	33 mm	28 mm	1 pièce



**Poignée en zamac type Kentucky**

- fixation: 2 x M4

N° de com.	Finition	E	L	H	h	L	
059504	fer vieilli mat	160 mm	180 mm	25 mm	20 mm	25 mm	1 pièce
059503	acier noir mat	160 mm	180 mm	25 mm	20 mm	25 mm	1 pièce



**Poignée en zamac type Derby**

- fixation: 2 x M4

N° de com.	Finition	E	L	H	h	L	
059500	fer vieilli mat	128 mm	169 mm	26 mm	20 mm	26 mm	1 pièce

**Poignée en zamac type Telford**

- fixation: 2 x M4



N° de com.	Finition	E	L	H	h	L	
059506	fer vieilli mat	160 mm	180 mm	30 mm	20 mm	10 mm	1 pièce
059508	fer vieilli mat	224 mm	244 mm	30 mm	20 mm	10 mm	1 pièce
059505	acier noir mat	160 mm	180 mm	30 mm	20 mm	10 mm	1 pièce
059507	acier noir mat	224 mm	244 mm	30 mm	20 mm	10 mm	1 pièce

**Boucle en cuir type 107**

- fixation: 2 x M4

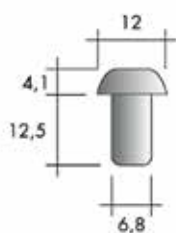

N° de com.	Finition	E	L	H	h	L	
057387	cuir naturel/nickelé	64 mm	125 mm	-	13 mm	5 mm	1 pièce
057388	cuir naturel/nickelé	128 mm	195 mm	-	13 mm	5 mm	1 pièce

## BOUTONS

## MODERN

**Bouton en inox type I2001**

- fixation: 1 x M4

N° de com.	Finition						
058225	inox brossée	-	25 mm	21 mm	-	-	1 pièce

**Bouton en inox type 207.430**

- fixation: 1 x M4

N° de com.	Finition						
056853	inox brossée	10 mm	10 mm	20 mm	-	-	1 pièce
056854	inox brossée	15 mm	15 mm	30 mm	-	-	1 pièce

**Bouton en inox type I2002**

- fixation: 1 x M4

N° de com.	Finition						
058228	inox brossée	15 mm	15 mm	22 mm	-	-	1 pièce
058229	inox brossée	21 mm	20 mm	25 mm	-	-	1 pièce

**Bouton en inox type D12**

- matière première: inox AISI 304

- fixation: 1 x M4

N° de com.	Finition					-	
016921	bronze mat	12 mm	12 mm	26 mm	-	-	1 pièce
016092	noir mat	12 mm	12 mm	26 mm	-	-	1 pièce



**Bouton en inox type D20**

- matière première: inox AISI 304  
- fixation: 1 x M4

N° de com.	Finition					-	
016922	bronze mat	20 mm	20 mm	26 mm	-	-	1 pièce
016990	noir mat	20 mm	20 mm	26 mm	-	-	1 pièce



**Bouton en laiton type 153R**

- chromé  
- fixation: 1 x M4

N° de com.	Finition						
056021	nickelée brillant	21 mm	21 mm	27 mm	-	-	1 pièce



**Bouton en inox type Hashtag**

- matière première: inox AISI 304  
- fixation: 1 x M4

N° de com.	Finition					-	
016908	noir mat	-	20 mm	25 mm	5 mm	-	1 pièce



**Bouton en inox type Cubica 12**





- matière première: inox AISI 304  
- fixation: 1 x M4

N° de com.	Finition					-	
016919	bronze mat	12 mm	12 mm	25 mm	-	-	1 pièce
016091	noir mat	12 mm	12 mm	25 mm	-	-	1 pièce

**Bouton en inox type Cubica 20**

- matière première: inox AISI 304







- fixation: 1 x M4

N° de com.	Finition					-	
016920	bronze mat	20 mm	20 mm	25 mm	-	-	1 pièce
016981	noir mat	20 mm	20 mm	25 mm	-	-	1 pièce

**Bouton en inox type X-treme**

- matière première: inox AISI 304







- fixation: 2 x M4

N° de com.	Finition						
016902	noir mat	20 mm	35 mm	30 mm	-	10 mm	1 pièce

**Bouton en inox type Seliz**







- matière première: inox AISI 304

- fixation: 2 x M4

N° de com.	Finition						
016897	noir mat	20 mm	37 mm	28 mm	-	7 mm	1 pièce

**Poignée en zamac type 8010**

- fixation: 1 x M4







N° de com.	Finition						
059446	blanc brillant	12 mm	12 mm	28 mm	-	12 mm	1 pièce
059447	noir brillant	12 mm	12 mm	28 mm	-	12 mm	1 pièce



**Bouton en zamac type 8102/8103**

- fixation: 1 x M4









N° de com.	Finition						
059168	inox look	-	32 x 32 mm	-	-	-	1 pièce



**Bouton en zamac type 8151**

- fixation: 1 x M4



N° de com.	Finition						
060397	or mat	22 x 22 mm	25 x 25 mm	28 mm	-	-	1 pièce
060406	graphite	22 x 22 mm	25 x 25 mm	28 mm	-	-	1 pièce
058918	inox look	22 x 22 mm	25 x 25 mm	28 mm	-	-	1 pièce

**Bouton en zamac type 8152**

- fixation: 1 x M4

N° de com.	Finition						
058921	inox look	13 x 13 mm	15 x 15 mm	24 mm	-	-	1 pièce

**Bouton en zamac type Disc 8342**

- fixation: 1 x M4

N° de com.	Finition					
060600	doré mat	28 mm	15 mm	23 mm	19 mm	1 pièce
060602	inox look	28 mm	15 mm	23 mm	19 mm	1 pièce
060603	blanc mat	28 mm	15 mm	23 mm	19 mm	1 pièce
060601	noir mat	28 mm	15 mm	23 mm	19 mm	1 pièce

**Bouton en zamac type 8161**

- fixation: 1 x M4

N° de com.	Finition						
060398	or mat	23 mm	25 mm	28 mm	-	-	1 pièce
060407	graphite	23 mm	25 mm	28 mm	-	-	1 pièce
058924	inox look	23 mm	25 mm	28 mm	-	-	1 pièce



**Bouton en zamac type 8162**

- fixation: 1 x M4

N° de com.	Finition						
058927	inox look	13 mm	15 mm	24 mm	-	-	1 pièce



**Bouton en zamac type Beluga**

- fixation: 2 x M4

N° de com.	Finition						
058697	inox look	16 mm	24 mm	30 mm	25 mm	42 mm	1 pièce



**Bouton en zamac type Align**

- fixation: 1 x M4

N° de com.	Finition						
059475	chromé mat	15 mm	15 mm	29 mm	-	-	1 pièce



**Bouton en zamac type 10122**

- fixation: 1 x M4

N° de com.	Finition						
058701	inox look	20 mm	20 mm	28 mm	-	-	1 pièce
058700	chromé mat	20 mm	20 mm	28 mm	-	-	1 pièce

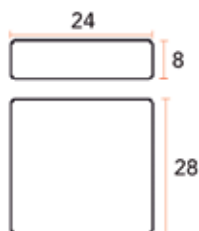

**Bouton en zamac type 120**

- fixation: 1 x M4

N° de com.	Finition	-	-	Unité de com.		
059537	nickelée mat	-	-	1 pièce		

**Bouton en zamac type 435**

- fixation: 1 x M4

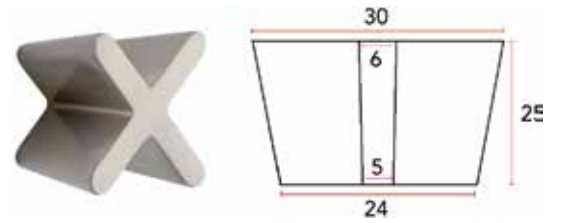

N° de com.	Finition	-	Unité de com.
059542	nickelée mat	-	1 pièce

**Bouton en zamac type 3405**

- fixation: 2 x M4

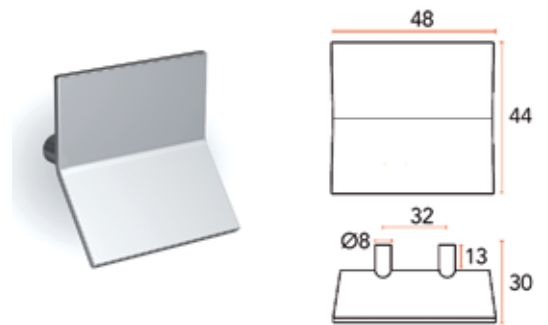

N° de com.	Finition	-	Unité de com.
059546	nickelée mat	-	1 pièce

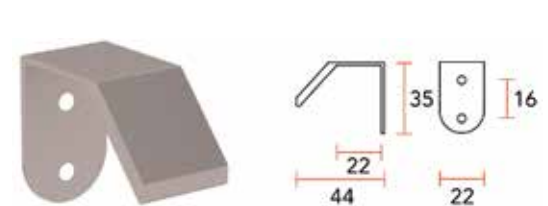
**Bouton en zamac type 3600**

N° de com.	Finition	-	Unité de com.
059547	nickelée mat	-	1 pièce

RETRO



**Bouton en laiton type Petra**

- matière première: laiton  
- fixation: 1 x M4

N° de com.	Finition						
016098	noir mat	17 mm	47 mm	35 mm	22 mm	17 mm	1 pièce



**Bouton en laiton type Olina**

- matière première: laiton  
- fixation: 1 x M4

N° de com.	Finition						
016093	noir mat	17 mm	39 mm	37 mm	23 mm	13 mm	1 pièce



**Poignée en zamac type Big Marcos**

- fixation: 1 x M4

N° de com.	Finition						
058952	acier vieux	-	24 mm	28 mm	-	24 mm	1 stuk
058949	acier noir	-	24 mm	28 mm	-	24 mm	1 pièce



**Bouton en métal type Spiralus**

- fixation inclus : 1 x M4

N° de com.	Finition						
016830	rouille vernis mat	14 mm	54 mm	28 mm	10 mm	18 mm	1 pièce

**Bouton en fer forgé type 143M**

- fixation: 1 x M4

N° de com.	Finition						
052231	1 - étain	18 mm	90 mm	55 mm	23 mm	30 mm	1 pièce
052232	2 - rouillée	18 mm	90 mm	55 mm	23 mm	30 mm	1 pièce

**Bouton en laiton type 165**

- fixation: 1 x M4

N° de com.	Finition						
056029	nickelée poli	24 mm	25 mm	33 mm	-	-	1 pièce
056081	nickelée mat	24 mm	25 mm	33 mm	-	-	1 pièce

**Bouton en laiton type 100**

- fixation: 1 x M4

N° de com.	Finition						
052098	laiton polie	19 mm	31 mm	28 mm	-	-	1 pièce

**Bouton en laiton type 158**

- bronze antique

- fixation: 1 x M4

N° de com.	Finition						
055221	bronze antique	25 mm	25 mm	24 mm	-	-	1 pièce

FANTASIE



**Bouton en aluminium et matière synthétique**

- fixation: 1 x M4

N° de com.	Description						
058842	short	15 mm	45 mm	26 mm	12 mm	37 mm	1 pièce



**Bouton en nylon type Babyline**

- fixation: 1 x M4

N° de com.	Finition						
059452	ours - rose	14 mm	47 mm	24 mm	12 mm	37 mm	1 pièce



**Bouton en nylon type Kidline**

- fixation: 1 x M4

N° de com.	Finition						
058844	bateau - bleu	14 mm	51 mm	21 mm	12 mm	35 mm	1 pièce

## POIGNÉES DE LA CAMPAGNE DAUBY

## PURE



Poignée Pure Type PMBU

- fixation: 2 x M4



N° de com.	Finition	E	L	H	h	
060535	1 - bronze brut	96 mm	154 mm	39 mm	32 mm	1 pièce
059972	1 - bronze brut	128 mm	184 mm	41 mm	34 mm	1 pièce
060451	1 - bronze brut	224 mm	370 mm	43 mm	36 mm	1 pièce
059336	2 - métal brut	96 mm	154 mm	39 mm	32 mm	1 pièce
059337	2 - métal brut	128 mm	184 mm	41 mm	34 mm	1 pièce
059338	2 - métal brut	224 mm	370 mm	43 mm	36 mm	1 pièce
059234	3 - fer vieilli	96 mm	154 mm	39 mm	32 mm	1 pièce
058771	3 - fer vieilli	128 mm	184 mm	41 mm	34 mm	1 pièce
059236	3 - fer vieilli	224 mm	370 mm	43 mm	36 mm	1 pièce



Bouton Pure Type PBU

- fixation: 1 x M4



N° de com.	Finition	L	Ø	H	h	
060428	1 - bronze brut	37 mm	12 mm	25 mm	21 mm	1 pièce
059879	1 - bronze brut	45 mm	16 mm	35 mm	29 mm	1 pièce
059861	2 - métal brut	37 mm	12 mm	25 mm	21 mm	1 pièce
059335	2 - métal brut	45 mm	16 mm	35 mm	29 mm	1 pièce
058763	3 - fer vieilli	37 mm	12 mm	25 mm	21 mm	1 pièce
058801	3 - fer vieilli	45 mm	16 mm	35 mm	29 mm	1 pièce
058764	4 - bronze blanc	37 mm	12 mm	25 mm	21 mm	1 pièce
058802	4 - bronze blanc	45 mm	16 mm	35 mm	29 mm	1 pièce



**Poignée Pure Type PMT**

- fixation: 2 x M4



N° de com.	Finition	E	L	H	h	L	
060593	1 - bronze brut	128 mm	190 mm	37 mm	31 mm	11 mm	1 pièce
059348	2 - métal brut	128 mm	190 mm	37 mm	31 mm	11 mm	1 pièce
059228	3 - fer vieilli	128 mm	190 mm	37 mm	31 mm	11 mm	1 pièce



**Bouton Pure type PTT**

- fixation: 1 x M4



N° de com.	Finition	L	Ø	H	h	
060594	1 - bronze brut	60 mm	10 mm	36 mm	30 mm	1 pièce
059347	2 - métal brut	60 mm	10 mm	36 mm	30 mm	1 pièce
059206	3 - fer vieilli	60 mm	10 mm	36 mm	30 mm	1 pièce
059207	4 - bronze blanc	60 mm	10 mm	36 mm	30 mm	1 pièce



**Bouton Pure type PQT**

- fixation: 1 x M4





N° de com.	Finition	L	Ø	H	h	
060654	1 - bronze brut	50 mm	16 mm	37 mm	25 mm	1 pièce
060631	2 - métal brut	50 mm	16 mm	37 mm	25 mm	1 pièce
060555	3 - fer vieilli	50 mm	16 mm	37 mm	25 mm	1 pièce



**Bouton Pure type PCRO**

- fixation: 1 x M4









N° de com.	Finition					
060632	1 - bronze brut	38 mm	-	27 mm	-	1 pièce
060633	2 - métal brut	38 mm	-	27 mm	-	1 pièce
060569	3 - fer vieilli	38 mm	-	27 mm	-	1 pièce



**Poignée Pure Type PMCRO**

- fixation: 2 x M4



N° de com.	Finition						
060634	1 - bronze brut	128 mm	166 mm	27 mm	-	38 mm	1 pièce
060635	1 - bronze brut	160 mm	200 mm	27 mm	-	38 mm	1 pièce
060636	2 - métal brut	128 mm	166 mm	27 mm	-	38 mm	1 pièce
060637	2 - métal brut	160 mm	200 mm	27 mm	-	38 mm	1 pièce
060638	3 - fer vieilli	128 mm	166 mm	27 mm	-	38 mm	1 pièce
060639	3 - fer vieilli	160 mm	200 mm	27 mm	-	38 mm	1 pièce



**Poignée Pure Type PMR**

- fixation: 2 x M4



N° de com.	Finition	E	L	H	h	L	
060640	1 - bronze brut	96 mm	126 mm	38 mm	-	22 mm	1 pièce
060388	2 - métal brut	96 mm	126 mm	38 mm	-	22 mm	1 pièce
059865	3 - fer vieilli	96 mm	126 mm	38 mm	-	22 mm	1 pièce



**Bouton Pure Type PT**

- fixation: 1 x M4



N° de com.	Finition	Ø	Ø	H	h	
060619	1 - bronze brut	20 mm	9 mm	27 mm	7 mm	1 pièce
059881	1 - bronze brut	25 mm	10 mm	35 mm	10 mm	1 pièce
059333	2 - métal brut	20 mm	9 mm	27 mm	7 mm	1 pièce
059334	2 - métal brut	25 mm	10 mm	35 mm	10 mm	1 pièce
058759	3 - fer vieilli	20 mm	9 mm	27 mm	7 mm	1 pièce
058761	3 - fer vieilli	25 mm	10 mm	35 mm	10 mm	1 pièce
058762	bronze blanc	25 mm	10 mm	35 mm	10 mm	1 pièce

**Bouton Pure type PFL**

- fixation: 1 x M4



N° de com.	Finition	P	H	L	
060620	1 - bronze brut	27 mm	52 mm	23 mm	1 pièce
060604	1 - bronze brut	30 mm	62 mm	24 mm	1 pièce
059355	2 - métal brut	27 mm	52 mm	23 mm	1 pièce
059356	2 - métal brut	30 mm	62 mm	24 mm	1 pièce
059208	3 - fer vieilli	27 mm	52 mm	23 mm	1 pièce
059209	3 - fer vieilli	30 mm	62 mm	24 mm	1 pièce

**Poignée Pure Type PMQ**

- fixation: 2 x M4









N° de com.	Finition	E	L	H	h	
059560	1 - bronze brut	96 mm	108 mm	40 mm	28 mm	1 pièce
060621	1 - bronze brut	128 mm	140 mm	40 mm	28 mm	1 pièce
060590	1 - bronze brut	160 mm	172 mm	40 mm	28 mm	1 pièce
059242	1 - bronze brut	224 mm	236 mm	40 mm	28 mm	1 pièce
060410	1 - bronze brut	384 mm	396 mm	40 mm	28 mm	1 pièce
059243	1 - bronze brut	512 mm	524 mm	40 mm	28 mm	1 pièce
059341	2 - métal brut	96 mm	108 mm	40 mm	28 mm	1 pièce
059342	2 - métal brut	128 mm	140 mm	40 mm	28 mm	1 pièce
059343	2 - métal brut	160 mm	172 mm	40 mm	28 mm	1 pièce
059344	2 - métal brut	224 mm	236 mm	40 mm	28 mm	1 pièce
059345	2 - métal brut	384 mm	396 mm	40 mm	28 mm	1 pièce
059346	2 - métal brut	512 mm	524 mm	40 mm	28 mm	1 pièce
058773	3 - fer vieilli	96 mm	108 mm	40 mm	28 mm	1 pièce
058775	3 - fer vieilli	128 mm	140 mm	40 mm	28 mm	1 pièce
058777	3 - fer vieilli	160 mm	172 mm	40 mm	28 mm	1 pièce
059232	3 - fer vieilli	224 mm	236 mm	40 mm	28 mm	1 pièce
059224	3 - fer vieilli	384 mm	396 mm	40 mm	28 mm	1 pièce
059226	3 - fer vieilli	512 mm	524 mm	40 mm	28 mm	1 pièce
058774	bronze blanc	96 mm	108 mm	40 mm	28 mm	1 pièce

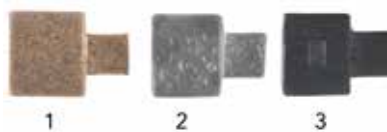

**Bouton Pure Type PQ**

- fixation: 1 x M4







N° de com.	Finition					
060622	1 - bronze brut	15 mm	9 mm	27 mm	13 mm	1 pièce
059862	1 - bronze brut	20 mm	11 mm	33 mm	13 mm	1 pièce
059363	1 - bronze brut	25 mm	13 mm	33 mm	13 mm	1 pièce
059364	1 - bronze brut	35 mm	-	38 mm	13 mm	1 pièce
059365	1 - bronze brut	45 mm	-	49 mm	13 mm	1 pièce
059864	2 - métal brut	15 mm	9 mm	27 mm	13 mm	1 pièce
059863	2 - métal brut	20 mm	11 mm	33 mm	13 mm	1 pièce
059340	2 - métal brut	25 mm	13 mm	33 mm	13 mm	1 pièce
059248	2 - métal brut	35 mm	-	38 mm	13 mm	1 pièce
060623	2 - métal brut	45 mm	-	49 mm	13 mm	1 pièce
058765	3 - fer vieilli	15 mm	9 mm	27 mm	13 mm	1 pièce
058767	3 - fer vieilli	20 mm	11 mm	33 mm	13 mm	1 pièce
059230	3 - fer vieilli	25 mm	13 mm	33 mm	13 mm	1 pièce
059246	3 - fer vieilli	35 mm	-	38 mm	13 mm	1 pièce
060624	3 - fer vieilli	45 mm	-	49 mm	13 mm	1 pièce



**Poignée Pure Type PML**

- fixation: 2 x M4
- fixation longueur 700 mm: 3 x M6







N° de com.	Finition	 E	 L	 H	 h	
060625	1 - bronze brut	32 mm	50 mm	27 mm	21 mm	1 pièce
060626	1 - bronze brut	64 mm	100 mm	27 mm	21 mm	1 pièce
059371	1 - bronze brut	96 mm	150 mm	27 mm	21 mm	1 pièce
060627	1 - bronze brut	2 x 250 mm	700 mm	27 mm	21 mm	1 pièce
059349	2 - métal brut	32 mm	50 mm	27 mm	21 mm	1 pièce
059350	2 - métal brut	64 mm	100 mm	27 mm	21 mm	1 pièce
059351	2 - métal brut	96 mm	150 mm	27 mm	21 mm	1 pièce
060628	2 - métal brut	2 x 250 mm	700 mm	27 mm	21 mm	1 pièce
058779	3 - fer vieilli	32 mm	50 mm	27 mm	21 mm	1 pièce
058781	3 - fer vieilli	64 mm	100 mm	27 mm	21 mm	1 pièce
058783	3 - fer vieilli	96 mm	150 mm	27 mm	21 mm	1 pièce
059101	3 - fer vieilli	2 x 250 mm	700 mm	27 mm	21 mm	1 pièce



**Poignée Pure Type PMSP**

- fixation: 2 x M4







N° de com.	Finition	 E	 L	 H	 h	
060629	1 - bronze brut	32 mm	50 mm	18 mm	15 mm	1 pièce
060630	1 - bronze brut	64 mm	100 mm	18 mm	15 mm	1 pièce
059352	2 - métal brut	32 mm	50 mm	18 mm	15 mm	1 pièce
059353	2 - métal brut	64 mm	100 mm	18 mm	15 mm	1 pièce
058785	3 - fer vieilli	32 mm	50 mm	18 mm	15 mm	1 pièce
058787	3 - fer vieilli	64 mm	100 mm	18 mm	15 mm	1 pièce



**Poignée Pure Type PCO**

- fixation: 2 x M4



N° de com.	Finition	 E	 L	 H	 h	
060060	1 - bronze brut	64 mm	82 mm	30 mm	25 mm	1 pièce
059339	2 - métal brut	64 mm	82 mm	30 mm	25 mm	1 pièce
058769	3 - fer vieilli	64 mm	82 mm	30 mm	25 mm	1 pièce



**Poignée pour porte coulissante Pure type PSS**

- fixation: 2 x 2,5x13 mm

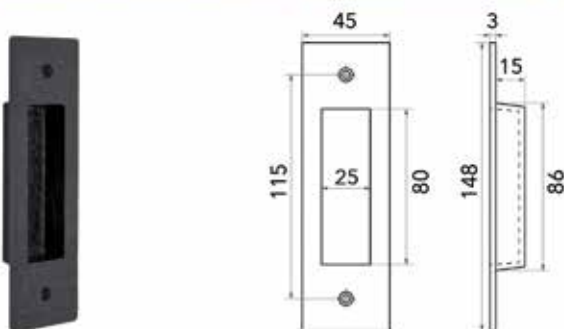

N° de com.	Finition	Largeur	Profondeur	Hauteur	Unité de com.
059888	fer vieilli	45 mm	15 mm	148 mm	1 pièce



**Poignée pour porte coulissante Pure type PSLD**

- fixation: 2 x M6

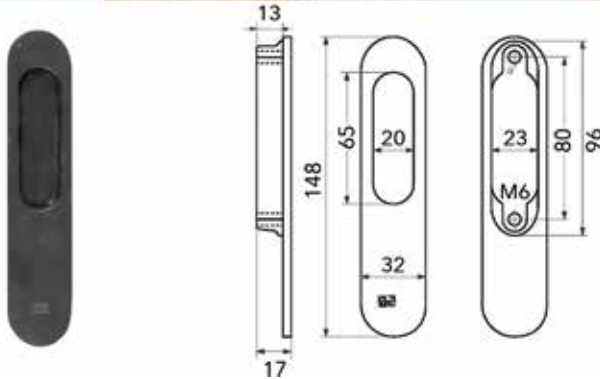

N° de com.	Finition	Largeur	Profondeur	Hauteur	Unité de com.
060422	fer vieilli	32 mm	13 mm	148 mm	1 pièce



**Mains courantes avec supports Pure Plus type PR**

- crochets à commander séparément

N° de com.	Finition	Longueur	Diamètre	Hauteur	Unité de com.
058791	fer vieilli	1000 mm	14 mm	65 mm	1 kit
059869	fer vieilli	1000 mm	14 mm	150 mm	1 kit



**Support Pure Plus type PRst**

- pour mains courantes type PR



N° de com.	Finition	Hauteur	Unité de com.
058803	fer vieilli	65 mm	1 pièce



**Crochet Pure Plus type PRh**  
- pour mains courantes type PR

N° de com.	Finition	Hauteur	Unité de com.
058793	fer vieilli	52 mm	1 pièce



**Portemanteau Pure Plus**

N° de com.	Finition	-	Unité de com.
058799	fer vieilli	-	1 pièce



**Crochet mural Pure Plus type PT-Q**

N° de com.	Finition	Plaque de montage	Profondeur	Unité de com.
059887	fer vieilli	50 x 50 mm	-	1 pièce



**Crochet mural Pure Plus type PT-R**

N° de com.	Finition	Plaque de montage	Profondeur	Unité de com.
059981	fer vieilli	dia. 50 mm	40 mm	1 pièce



**Crochet mural Pure Plus type PTT**

N° de com.	Finition	Plaque de montage	Profondeur	Unité de com.
060611	fer vieilli	50 x 50 mm	40 mm	1 pièce



Porte-papier Pure Plus



N° de com.	Finition	Longueur	Unité de com.
058795	fer vieilli	350 mm	1 pièce



Porte-papier toilet Pure Plus

N° de com.	Finition	Longueur	Unité de com.
058797	fer vieilli	150 mm	1 pièce



Brosse de toilette Pure Plus

- le kit contient:
- porte-brosse
- pot
- brosse

N° de com.	Finition	-	Unité de com.
059940	fer vieilli/pot noir	-	1 kit
059944	fer vieilli/pot blanc	-	1 kit



**Mains courantes avec supports Pure Q**

- crochets à commander séparément

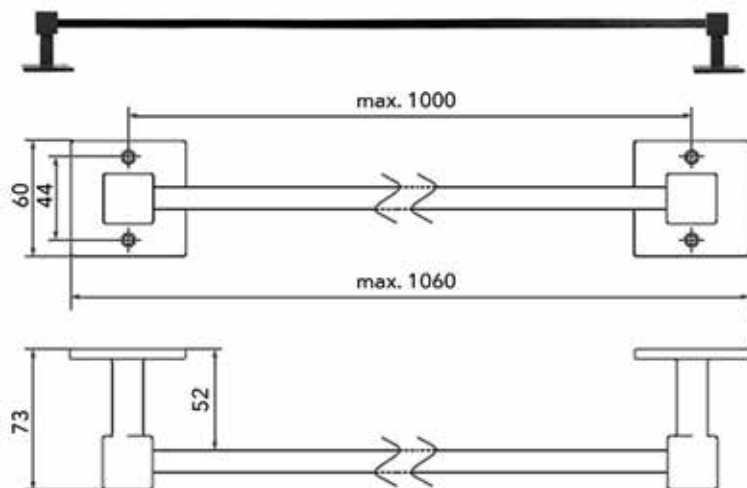

N° de com.	Finition	Longueur	Diamètre	Hauteur	Unité de com.
060450	fer vieilli	1000 mm	14 x 14 mm	70 mm	1 kit



**Support Pure Plus Q type PRst**

- pour mains courantes type Pure Plus Q

N° de com.	Finition	Hauteur	Unité de com.
060649	fer vieilli	70 mm	1 pièce



**Crochet Pure Plus Q type PRh**

- pour mains courantes Pure Plus Q

N° de com.	Finition	Hauteur	Unité de com.
060426	fer vieilli	50 mm	1 pièce



Porte-papier Pure Plus Q

N° de com.	Finition	Longueur	Unité de com.
060650	fer vieilli	370 mm	1 pièce



Porte-papier toilet Pure Plus Q

N° de com.	Finition	Longueur	Unité de com.
060651	fer vieilli	170 mm	1 pièce

POIGNÉES DE PORTES PURE



Poignée Pure type PH1920 /QU  
- par paire

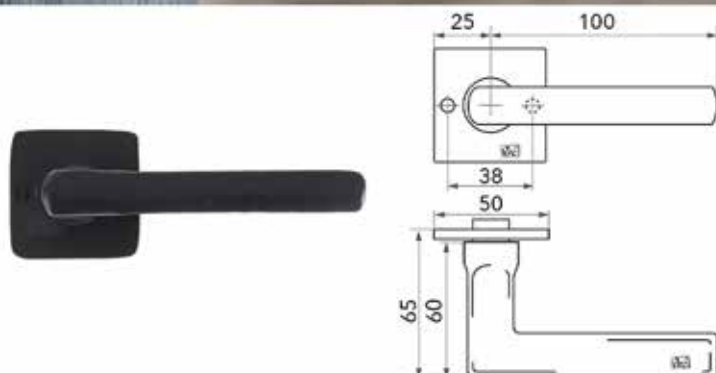

N° de com.	Finition	-	Unité de com.
058808	fer vieilli	-	1 paire



Poignée Pure type PHTL'T+L' 50-R  
- par paire

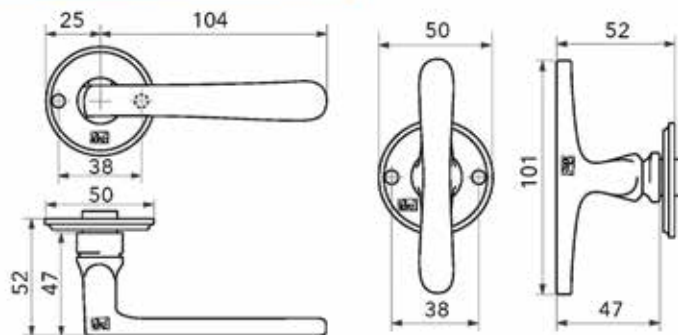

N° de com.	Finition	-	Unité de com.
059095	fer vieilli	-	1 paire



**Poignée Pure type PHL'L+L' 50R**  
- par paire

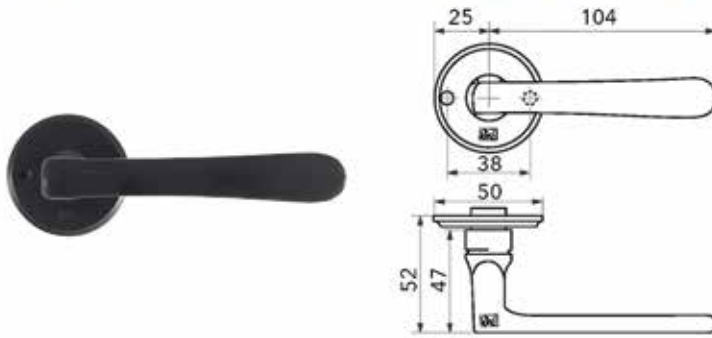

N° de com.	Finition	-	Unité de com.
059105	fer vieilli	-	1 paire



**Poignée Pure type PH1928 /QU**  
- par paire

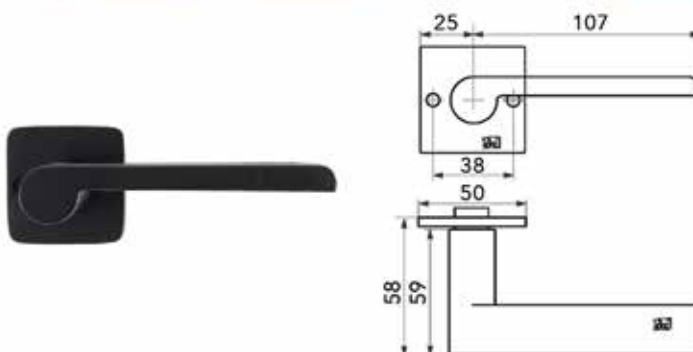

N° de com.	Finition	-	Unité de com.
059110	fer vieilli	-	1 paire



**Poignée Pure type PHT'T+T' 50-R**

- par paire

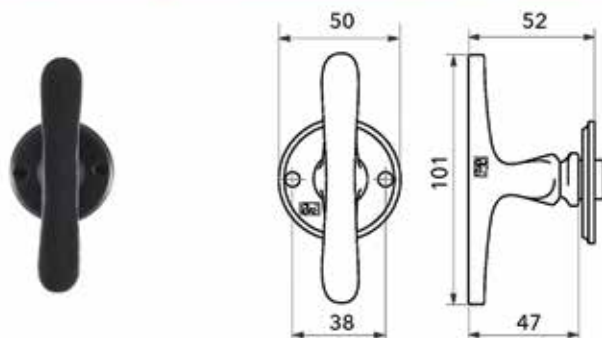

N° de com.	Finition	-	Unité de com.
059374	fer vieilli	-	1 paire

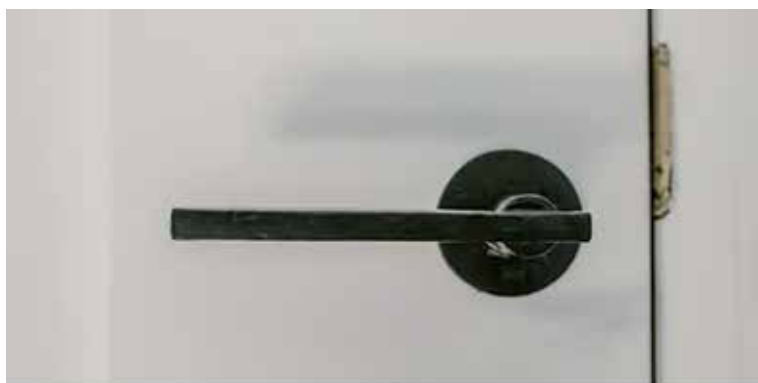

**Poignée Pure type PH2017 /50F**

- par paire

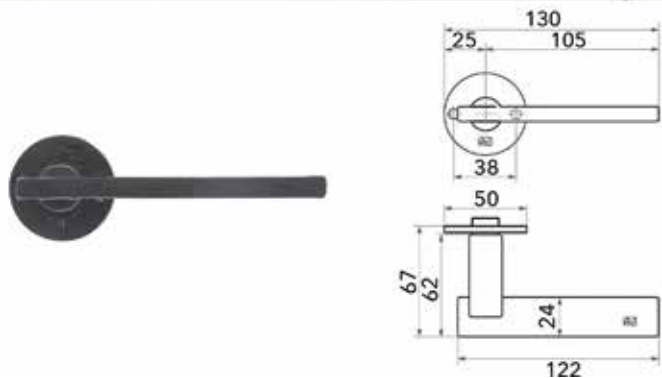

N° de com.	Finition	-	Unité de com.
060552	fer vieilli	-	1 paire



**Poignée Pure type PH1928 /50F**  
- par paire



N° de com.	Finition	-	Unité de com.
060794	fer vieilli	-	1 paire

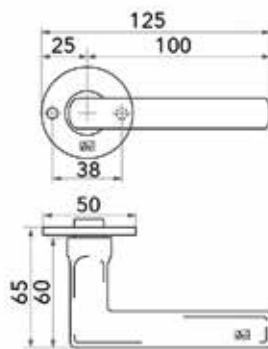

**Poignée Pure type PH1920 /50F**  
- par paire

N° de com.	Finition	-	Unité de com.
060810	fer vieilli	-	1 paire

CDF



**Bouton en fer forgé CDF type BT294**

- fixation: 1 x M4

N° de com.	Finition						
058493	1 - fer forgé	13 mm	37 mm	26 mm	15 mm	13 mm	1 pièce
058492	2 - rouillée	13 mm	37 mm	26 mm	15 mm	13 mm	1 pièce
059213	3 - noir	13 mm	37 mm	26 mm	15 mm	13 mm	1 pièce



**Bouton en fer forgé CDF type BT254/BT284**

- fixation: 1 x M4

N° de com.	Finition						
058621	1 - fer forgé	16 mm	45 mm	37 mm	22 mm	14 mm	1 pièce
058505	1 - fer forgé	18 mm	65 mm	55 mm	35 mm	25 mm	1 pièce
058622	2 - rouillée	16 mm	45 mm	37 mm	22 mm	14 mm	1 pièce
058504	2 - rouillée	18 mm	65 mm	55 mm	35 mm	25 mm	1 pièce
059214	3 - noir	16 mm	45 mm	37 mm	22 mm	14 mm	1 pièce
059215	3 - noir	18 mm	65 mm	55 mm	35 mm	25 mm	1 pièce



**Bouton en fer forgé CDF type BT267**

- fixation: 1 x M4

N° de com.	Finition						
058494	1 - fer forgé	12 mm	31 mm	26 mm	19 mm	-	1 pièce
058495	2 - rouillée	12 mm	31 mm	26 mm	19 mm	-	1 pièce
059217	3 - noir	12 mm	31 mm	26 mm	19 mm	-	1 pièce



**Bouton en fer forgé CDF type BT304-bis**

- fixation: 1 x M4

N° de com.	Finition						
058500	1 - fer forgé	16 mm	28 mm	32 mm	20 mm	-	1 pièce
058501	2 - rouillée	16 mm	28 mm	32 mm	20 mm	-	1 pièce
059219	3 - noir	16 mm	28 mm	32 mm	20 mm	-	1 pièce



**Bouton en fer forgé CDF type BT270**

- fixation: 1 x M4

N° de com.	Finition						
058499	1 - fer forgé	11 mm	23 mm	21 mm	12 mm	-	1 pièce
058498	2 - rouillée	11 mm	23 mm	21 mm	12 mm	-	1 pièce
059218	3 - noir	11 mm	23 mm	21 mm	12 mm	-	1 pièce







**Bouton en fer forgé CDF type Chemin de Fer**

- fixation: 1 x M4

N° de com.	Finition						
059222	1 - fer forgé	-	45 mm	40 mm	-	-	1 pièce
059223	2 - rouillée	-	45 mm	40 mm	-	-	1 pièce
059220	3 - noir	-	45 mm	40 mm	-	-	1 pièce







**Poignée en fer forgé CDF type Chemin de Fer**  
- fixation: 2 x M4

N° de com.	Finition					
060642	1 - fer forgé	96 mm	135 mm	36 mm	-	1 pièce
060644	1 - fer forgé	128 mm	168 mm	36 mm	-	1 pièce
060647	1 - fer forgé	160 mm	200 mm	36 mm	-	1 pièce
060643	2 - rouillé	96 mm	135 mm	36 mm	-	1 pièce
060645	2 - rouillé	128 mm	168 mm	36 mm	-	1 pièce
060648	2 - rouillé	160 mm	200 mm	36 mm	-	1 pièce
060641	3 - noir	96 mm	135 mm	36 mm	-	1 pièce
061003	3 - noir	128 mm	168 mm	36 mm	-	1 pièce
060646	3 - noir	160 mm	200 mm	36 mm	-	1 pièce







**Poignée en fer forgé CDF type P13**  
- fixation: 2 x M4

N° de com.	Finition					
059479	1 - fer poli	135 mm	155 mm	35 mm	-	1 pièce
059362	2 - rouillé	135 mm	155 mm	35 mm	-	1 pièce
059404	3 - noir	135 mm	155 mm	35 mm	-	1 pièce



**Poignée CDF Type Retro**

N° de com.	Finition					
059878	noir	79 mm	91 mm	41 mm	-	1 pièce



Cuvette CDF type P46



N° de com.	Finition	E	L	H	h	L	
059875	fer forgé	-	85 mm	-	-	40 mm	1 pièce

## GIARA

**Bouton en Britannium Giara  
type 304-bis**

- Britannium est un alliage d'argent et d'étain  
- fixation: 1 x M4









N° de com.	Finition	Ø	Ø	H	h	L	
058534	britannium	12 mm	20 mm	27 mm	18 mm	+/- 20-21 mm	1 pièce
058510	britannium	16 mm	30 mm	32 mm	20 mm	+/- 29-30 mm	1 pièce
060653	britannium	-	40 mm	40 mm	25 mm	-	1 pièce



**Bouton en Britannium Giara  
type Country Line C62**

- Britannium est un alliage d'argent et d'étain  
- fixation: 1 x M4









N° de com.	Finition						
058508	britannium	16 mm	-	33 mm	20 mm	+/- 33 mm	1 pièce



**Poignée en Britannium Giara  
type Country Line**

- Britannium est un alliage d'argent et d'étain  
- fixation: 2 x M4









N° de com.	Finition						
058506	britannium	96 mm	125 mm	33 mm	25 mm	10 mm	1 pièce
058542	britannium	128 mm	156 mm	35 mm	25 mm	12 mm	1 pièce
058507	britannium	160 mm	180 mm	35 mm	25 mm	12 mm	1 pièce



**Bouton Giara**  
**type Chemin de Fer**

- Britannium est un alliage d'argent et d'étain  
- fixation: 1 x M4









N° de com.	Finition						
<b>058509</b>	1 - britannium	14 mm	46 mm	36 mm	20 mm	17 mm	1 pièce
<b>058603</b>	2 - nickelée mat	16 mm	48 mm	38 mm	24 mm	18 mm	1 pièce



**Poignée en Britannium Giara**  
**type Chemin de Fer Ma8**

- Britannium est un alliage d'argent et d'étain  
- fixation: 2 x M4







N° de com.	Finition						
<b>058535</b>	britannium	64 mm	98 mm	36 mm	23 mm	8 mm	1 pièce
<b>058536</b>	britannium	96 mm	128 mm	36 mm	23 mm	8 mm	1 pièce
<b>058537</b>	britannium	128 mm	168 mm	36 mm	23 mm	8 mm	1 pièce
<b>058538</b>	britannium	224 mm	258 mm	36 mm	23 mm	10 mm	1 pièce
<b>058539</b>	britannium	384 mm	428 mm	43 mm	27 mm	11 mm	1 pièce
<b>058540</b>	britannium	512 mm	556 mm	43 mm	27 mm	11 mm	1 pièce



**Bouton en Britannium Giara  
type PO.IN**

- Britannium est un alliage d'argent et d'étain  
- fixation: 1 x M4









N° de com.	Finition						
058544	britannium	13 mm	35 mm	26 mm	16 mm	11 mm	1 pièce
058545	britannium	16 mm	46 mm	36 mm	22 mm	14 mm	1 pièce
058546	britannium	22 mm	59 mm	58 mm	38 mm	24 mm	1 pièce



**Bouton en Britannium Giara  
type C64-48**

- Britannium est un alliage d'argent et d'étain  
- fixation: 1 x M4









N° de com.	Finition						
058550	britannium	16 mm	-	33 mm	15 mm	21 mm	1 pièce



**Poignée en Britannium Giara  
type MAR-25**

- Britannium est un alliage d'argent et d'étain

N° de com.	Finition						
058543	britannium	25 mm	34 mm	34 mm	43 mm	8 mm	1 pièce

PROFILS POIGNÉES

PROFILS POIGNÉES

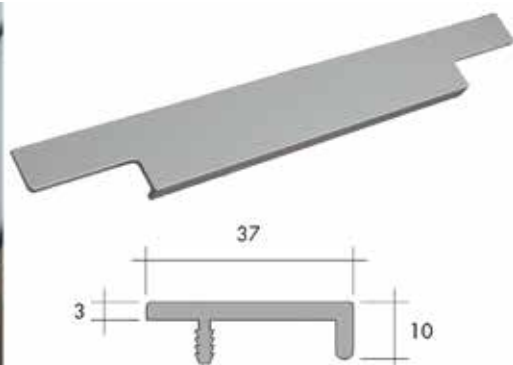

Poignée profil type 901.365

N° de com.	Finition	E	L	H	h	L	
047579	anodisée mat	-	295 mm	10 mm	-	37 mm	1 pièce
047580	anodisée mat	-	395 mm	10 mm	-	37 mm	1 pièce
047581	anodisée mat	-	445 mm	10 mm	-	37 mm	1 pièce
047582	anodisée mat	-	495 mm	10 mm	-	37 mm	1 pièce
047583	mat anodisée	-	595 mm	10 mm	-	37 mm	1 pièce
047584	mat anodisée	-	795 mm	10 mm	-	37 mm	1 pièce
047585	anodisée mat	-	895 mm	10 mm	-	37 mm	1 pièce
047586	anodisée mat	-	1195 mm	10 mm	-	37 mm	1 pièce
047587	inox look	-	295 mm	10 mm	-	37 mm	1 pièce
047588	inox look	-	395 mm	10 mm	-	37 mm	1 pièce
047589	inox look	-	445 mm	10 mm	-	37 mm	1 pièce
047590	inox look	-	495 mm	10 mm	-	37 mm	1 pièce
047591	inox look	-	595 mm	10 mm	-	37 mm	1 pièce
047592	inox look	-	795 mm	10 mm	-	37 mm	1 pièce
047593	inox look	-	895 mm	10 mm	-	37 mm	1 pièce
047594	inox look	-	1195 mm	10 mm	-	37 mm	1 pièce

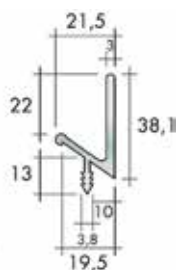

Profil poignée type 901.189

N° de com.	Finition	E	L	H	h	L	
047276	anodisée mat	-	295 mm	38,1 mm	-	21,5 mm	1 pièce
047277	anodisée mat	-	395 mm	38,1 mm	-	21,5 mm	1 pièce
047278	anodisée mat	-	445 mm	38,1 mm	-	21,5 mm	1 pièce
047279	anodisée mat	-	495 mm	38,1 mm	-	21,5 mm	1 pièce
047281	anodisée mat	-	895 mm	38,1 mm	-	21,5 mm	1 pièce
047282	anodisée mat	-	1195 mm	38,1 mm	-	21,5 mm	1 pièce

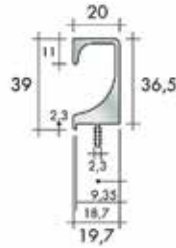

Profil poignée type 900303

N° de com.	Finition	E	L	H	h	L	
047283	anodisée mat	-	295 mm	36,5 mm	-	20 mm	1 pièce
047284	anodisée mat	-	395 mm	36,5 mm	-	20 mm	1 pièce
047285	anodisée mat	-	445 mm	36,5 mm	-	20 mm	1 pièce
047286	anodisée mat	-	495 mm	36,5 mm	-	20 mm	1 pièce
047287	anodisée mat	-	595 mm	36,5 mm	-	20 mm	1 pièce
047288	anodisée mat	-	895 mm	36,5 mm	-	20 mm	1 pièce
047289	anodisée mat	-	1195 mm	36,5 mm	-	20 mm	1 pièce

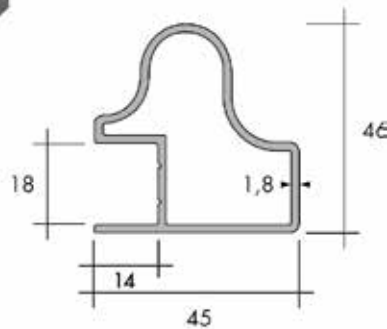
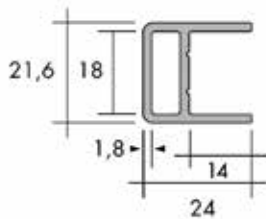

profil de renforcement

profil-poignée

**Profil-poignée et profil de renforcement**

- muni de trous de vis
- 2 poignées (gauche/droite) sur la porte arrière ne sont pas possibles
- pour panneau de 18 mm
- 1 pièce = 2500 mm

N° de com.	Finition	Description	Longueur	Unité de com.
046279	argent	profil-poignée	2500 mm	1 pièce
046282	argent	profil de renforcement	2500 mm	1 pièce
046286	blanc	profil-poignée	2500 mm	1 pièce
046287	blanc	profil de renforcement	2500 mm	1 pièce

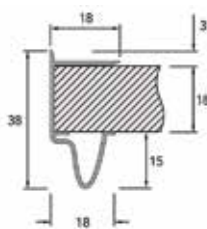

**Profil-poignée type 1226 AF**

- muni de trous de vis
- 1 pièce = 3000 mm

N° de com.	Finition	Longueur	Unité de com.
333272	aluminium	3000 mm	1 pièce

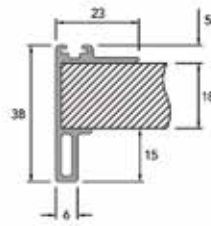

**Profil poignée type 1227 AF**

- muni de trous de vis

- 1 pièce = 3000 mm

N° de com.	Finition	Longueur	Unité de com.
333267	aluminium	3000 mm	1 pièce

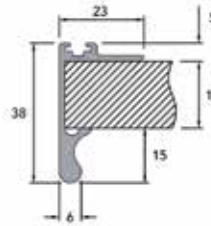

**Profil poignée type 1228 AF**

- muni de trous de vis

- 1 pièce = 3000 mm

N° de com.	Finition	Longueur	Unité de com.
333268	aluminium	3000 mm	2 pièces

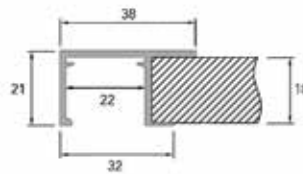
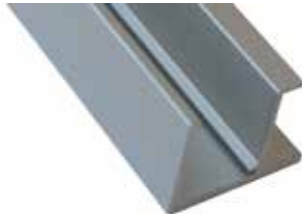

**Profil poignée type Sima 8110**

- 1 pièce = 2750 mm

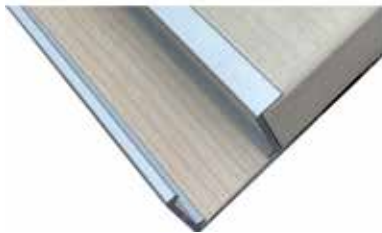

N° de com.	Finition	Longueur	Unité de com.
013714	aluminium	2750 mm	1 pièce

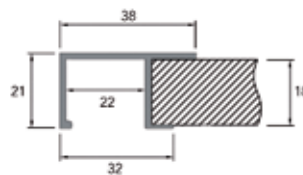
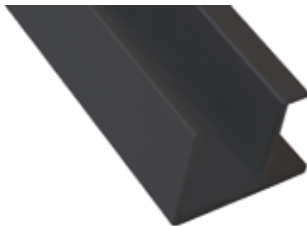

**Profil poignée type Sima 8111**

- 1 pièce = 2700 mm

N° de com.	Finition	Longueur	Unité de com.
013648	noir mat	2700 mm	1 pièce

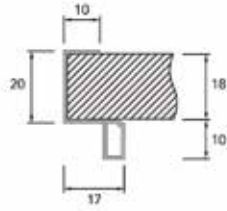
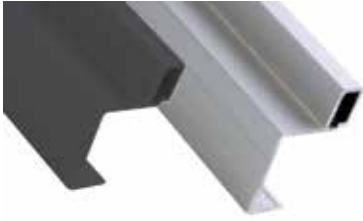

**Profil poignée type Sima 8720**

- 1 pièce = 1 longueur

N° de com.	Finition	Longueur	Unité de com.
013715	aluminium	2750 mm	1 pièce
013649	noir mat	2700 mm	1 pièce

PROFILS-POIGNÉE GOLA L

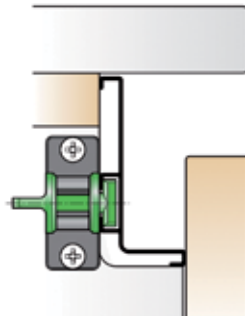
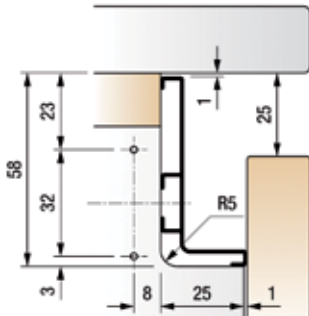
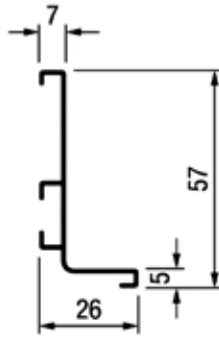

**Profil-poignée Gola L**

- embouts à commander séparément
- kit de fixation Golafix à commander séparément
- 1 pièce = 4000 mm

N° de com.	Finition	Longueur	Unité de com.
034800	aluminium anodisé	4000 mm	1 pièce
034803	anthracite lacqué	4000 mm	1 pièce
034802	blanc mat lacqué (RAL 9003)	4000 mm	1 pièce
034801	noir mat lacqué (RAL 9005)	4000 mm	1 pièce

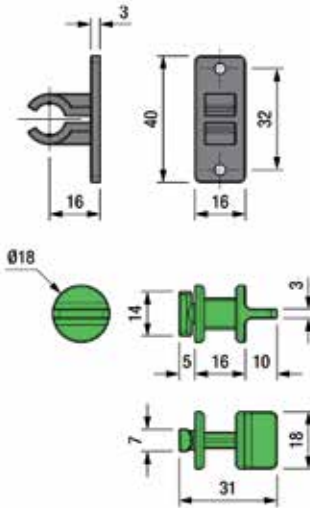

**Fixation Golafix**

- pour profils-poignée Gola L et C
- par kit (1 x plaquette de fixation noire + 1 x clips vert)

N° de com.	Finition	-	Unité de com.
034816	noir/vert	-	1 kit

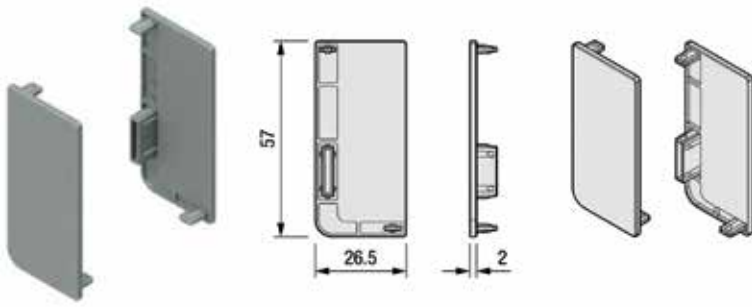

**Embout Gola L**  
- par kit (2 pièces)

N° de com.	Finition	-	Unité de com.
034820	anthracite	-	1 kit
034817	gris	-	1 kit
034819	blanc (RAL 9003)	-	1 kit
034818	noir (RAL 9005)	-	1 kit

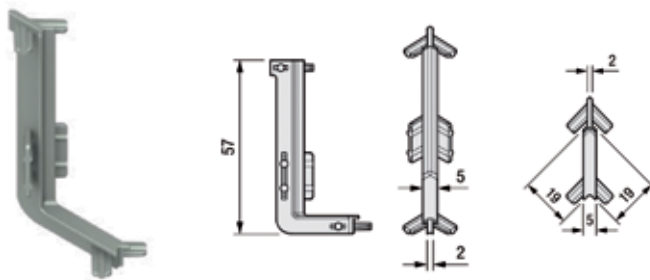

**Pièce d'angle intérieure Gola L**

N° de com.	Finition	-	Unité de com.
034824	anthracite	-	1 pièce
034821	gris	-	1 pièce
034823	blanc (RAL 9003)	-	1 pièce
034822	noir (RAL 9005)	-	1 pièce

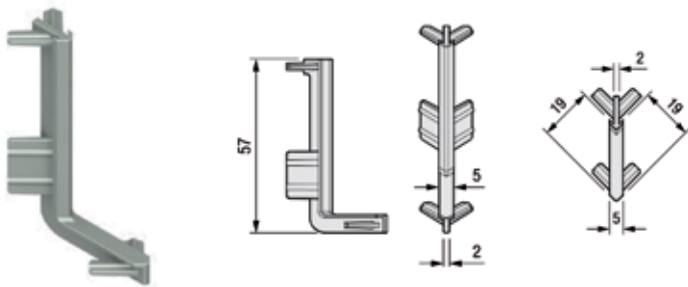

**Pièce d'angle extérieure Gola L**

N° de com.	Finition	-	Unité de com.
034828	anthracite	-	1 pièce
034825	gris	-	1 pièce
034827	blanc (RAL 9003)	-	1 pièce
034826	noir (RAL 9005)	-	1 pièce

PROFILS-POIGNÉE GOLA L LED

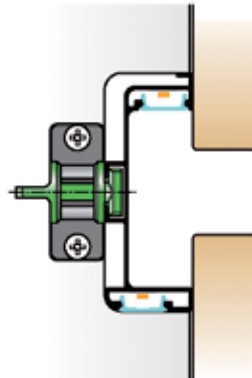
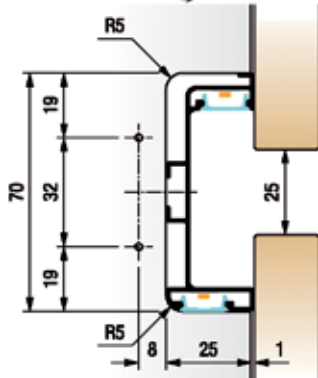
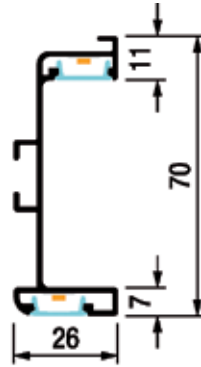
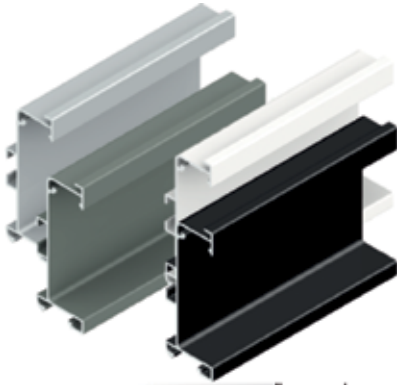

**Profil-poignée Gola L Led**

- avec rainure pour bande Led
- convient pour les bandes led: HE6B PW PRO, UHE6B PW et HE CR
- embouts, diffuseur opaque et kit de fixation Golafix à commander séparément

- 1 pièce = 4000 mm

N° de com.	Finition	Longueur	Unité de com.
034874	anthracite	4000 mm	1 pièce
034873	blanc (RAL 9003)	4000 mm	1 pièce
034871	argent	4000 mm	1 pièce
034872	noir (RAL 9005)	4000 mm	1 pièce

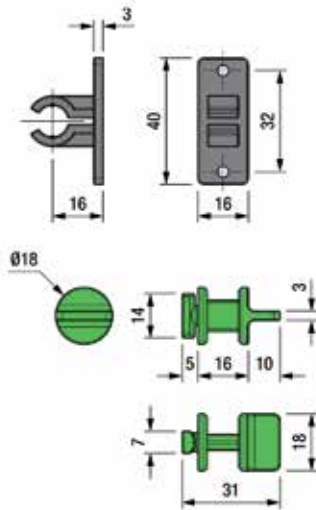
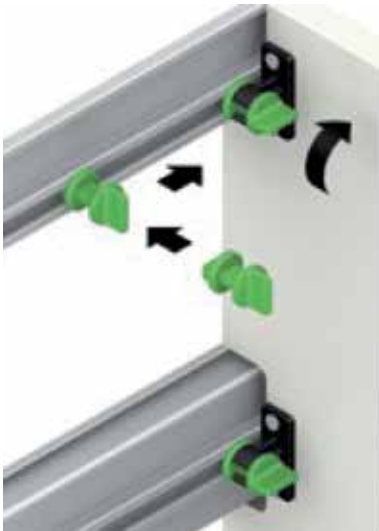

**Fixation Golafix**

- pour profils-poignée Gola L et C

- par kit (1 x plaquette de fixation noire + 1 x clips vert)

N° de com.	Finition	-	Unité de com.
034816	noir/vert	-	1 kit

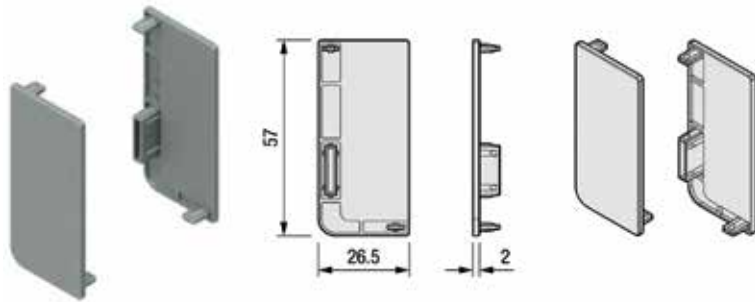

**Embouts Gola L Led**

- par kit (2 pièces)

N° de com.	Finition	-	Unité de com.
034820	anthracite	-	1 kit
034817	gris	-	1 kit
034819	blanc (RAL 9003)	-	1 kit
034818	noir (RAL 9005)	-	1 kit

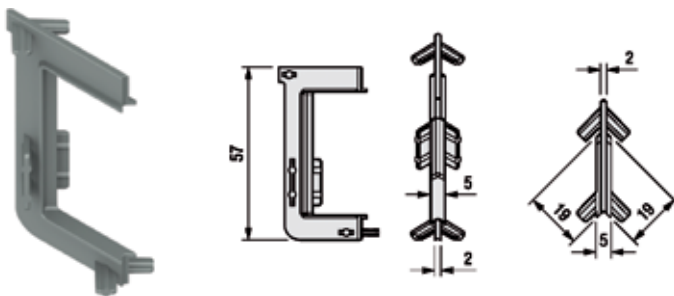

**Pièce d'angle intérieure Gola L Led**

N° de com.	Finition	-	Unité de com.
034886	anthracite	-	1 pièce
034883	gris	-	1 pièce
034885	blanc (RAL 9003)	-	1 pièce
034884	noir (RAL 9005)	-	1 pièce

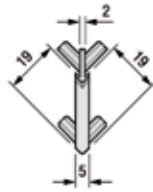
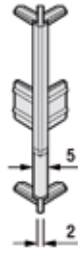
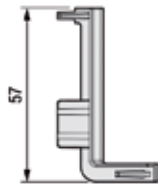

Pièce d'angle extérieure Gola L Led

N° de com.	Finition	-	Unité de com.
034882	anthracite	-	1 pièce
034879	gris	-	1 pièce
034881	blanc (RAL 9003)	-	1 pièce
034880	noir (RAL 9005)	-	1 pièce

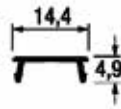

Diffuseur Gola

- pour profils Gola Led

- 1 pièce = 4000 mm

N° de com.	Finition	Longueur	Unité de com.
034895	opale	4000 mm	1 pièce

PROFILS-POIGNÉE GOLA C

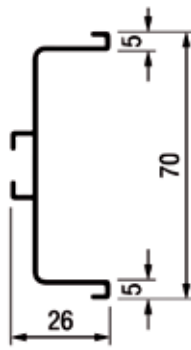
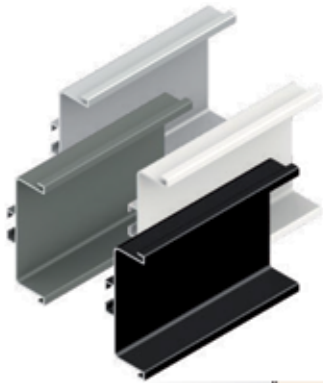

**Profil-poignée Gola C**

- embouts à commander séparément
- kit de fixation Golafix à commander séparément

- 1 pièce = 4000 mm

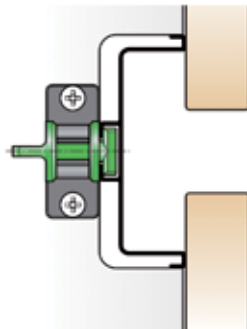
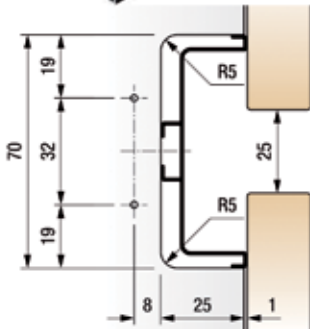

N° de com.	Finition	Longueur	Unité de com.
034804	aluminium anodisé	4000 mm	1 pièce
034807	anthracite lacqué	4000 mm	1 pièce
034806	blanc mat lacqué (RAL 9003)	4000 mm	1 pièce
034805	noir mat lacqué (RAL 9005)	4000 mm	1 pièce

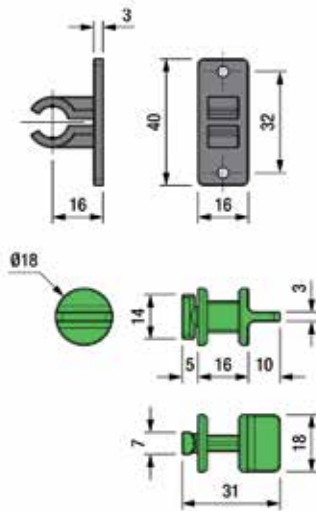

**Fixation Golafix**

- pour profils-poignée Gola L et C

- par kit (1 x plaquette de fixation noire + 1 x clips vert)

N° de com.	Finition	-	Unité de com.
034816	noir/vert	-	1 kit

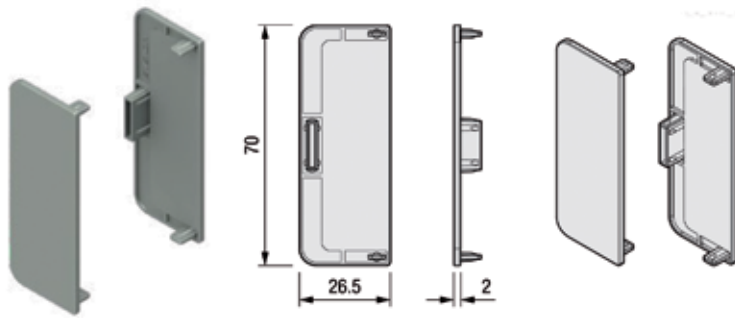

**Embouts Gola C**  
- par set (2 pièces)

N° de com.	Finition	-	Unité de com.
034832	anthracite	-	1 kit
034829	gris	-	1 kit
034831	blanc (RAL 9003)	-	1 kit
034830	noir (RAL 9005)	-	1 kit

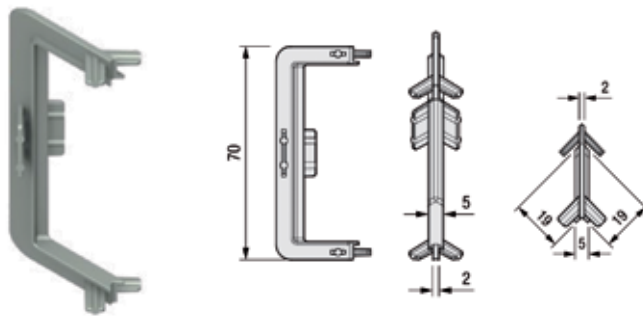

**Pièce d'angle intérieure Gola C**

N° de com.	Finition	-	Unité de com.
034836	anthracite	-	1 pièce
034833	gris	-	1 pièce
034835	blanc (RAL 9003)	-	1 pièce
034834	noir (RAL 9005)	-	1 pièce

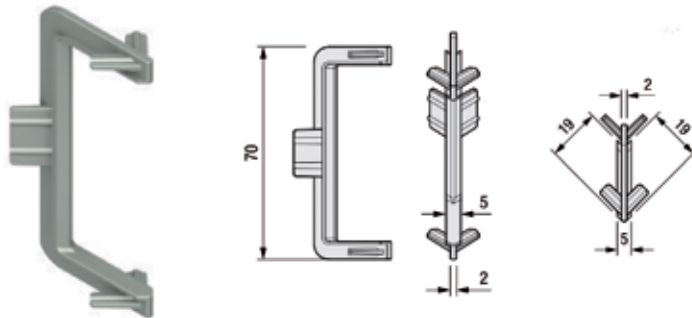

**Pièce d'angle extérieure Gola C**

N° de com.	Finition	-	Unité de com.
034840	anthracite	-	1 pièce
034837	gris	-	1 pièce
034839	blanc (RAL 9003)	-	1 pièce
034838	noir (RAL 9005)	-	1 pièce

## PROFILS-POIGNÉE GOLA C LED

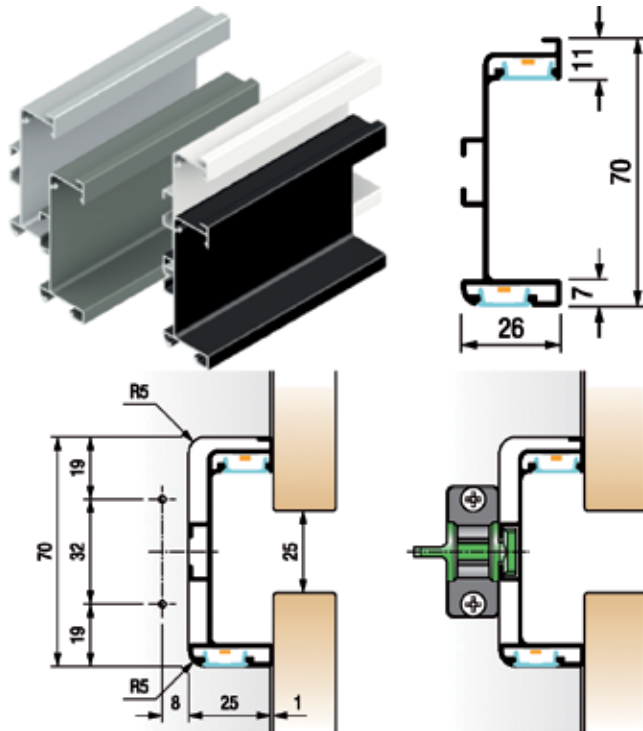

### Profil-poignée Gola C Led

- avec rainure pour bande Led
- convient pour les bandes led: HE6B PW PRO, UHE6B PW et HE CR
- embouts, diffuseur opaque et kit de fixation Golafix à commander séparément

- 1 pièce = 4000 mm

N° de com.	Finition	Longueur	Unité de com.
034878	anthracite	4000 mm	1 pièce
034877	blanc (RAL 9003)	4000 mm	1 pièce
034875	argent	4000 mm	1 pièce
034876	noir (RAL 9005)	4000 mm	1 pièce

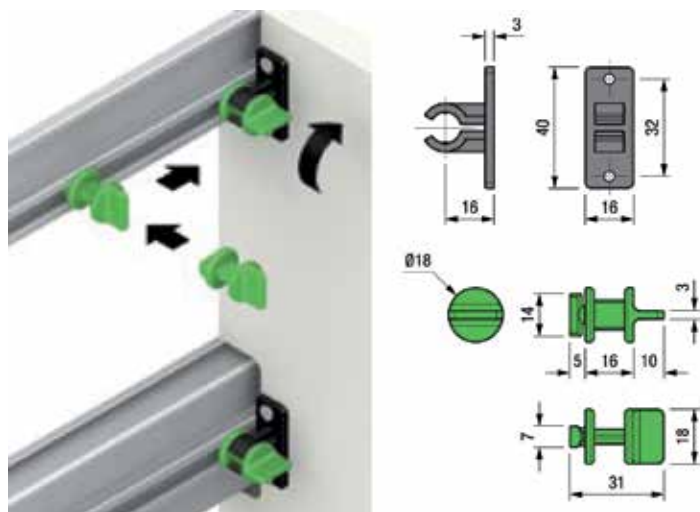

### Fixation Golafix

- pour profils-poignée Gola L et C

- par kit (1 x plaquette de fixation noire + 1 x clips vert)

N° de com.	Finition	-	Unité de com.
034816	noir/vert	-	1 kit

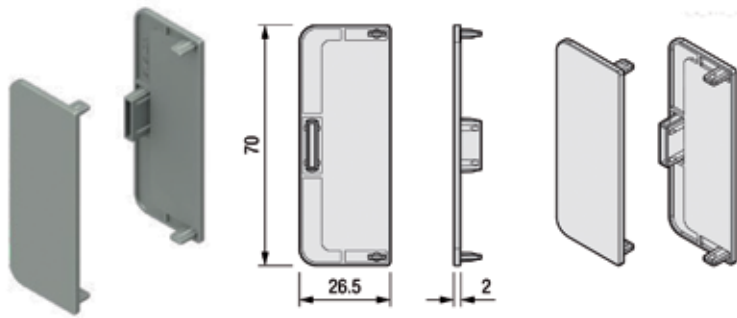

**Embouts Gola C Led**  
- par set (2 pièces)

N° de com.	Finition	-	Unité de com.
034832	anthracite	-	1 kit
034829	gris	-	1 kit
034831	blanc (RAL 9003)	-	1 kit
034830	noir (RAL 9005)	-	1 kit

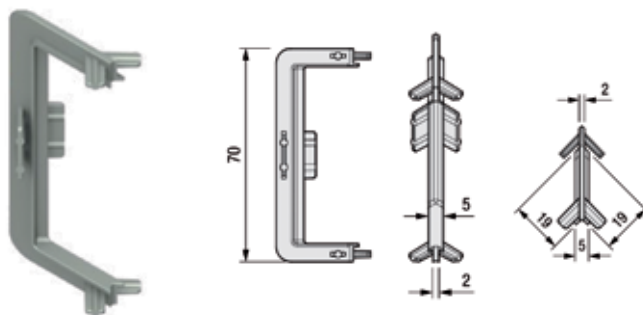

**Pièce d'angle intérieure Gola C Led**

N° de com.	Finition	-	Unité de com.
034893	anthracite	-	1 pièce
034891	gris	-	1 pièce
034894	blanc (RAL 9003)	-	1 pièce
034892	noir (RAL 9005)	-	1 pièce

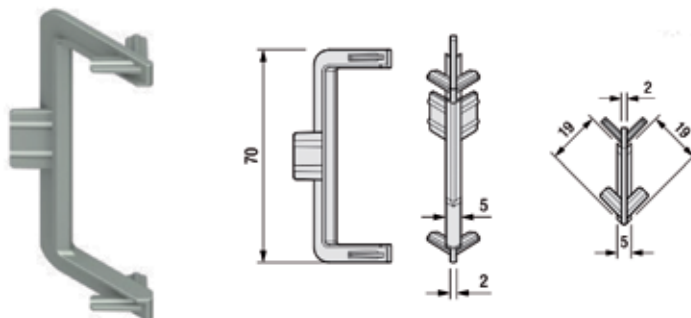

**Pièce d'angle extérieure Gola C Led**

N° de com.	Finition	-	Unité de com.
034889	anthracite	-	1 pièce
034887	gris	-	1 pièce
034890	blanc (RAL 9003)	-	1 pièce
034888	noir (RAL 9005)	-	1 pièce

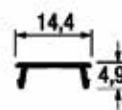

**Diffuseur Gola**  
- pour profils Gola Led  
- 1 pièce = 4000 mm

N° de com.	Finition	Longueur	Unité de com.
034895	opale	4000 mm	1 pièce

PROFILS VERTICAL GOLA

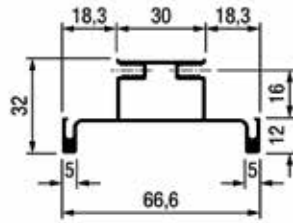
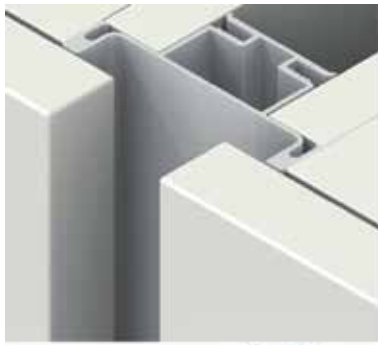

**Profil vertical Gola: central**

- 1 pièce = 2600 mm

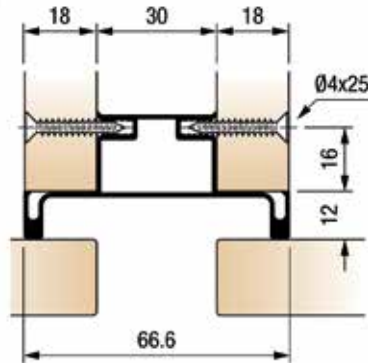

N° de com.	Finition	Longueur	Unité de com.
034808	aluminium anodisé	2600 mm	1 pièce
034811	anthracite lacqué	2600 mm	1 pièce
034810	blanc mat lacqué (RAL 9003)	2600 mm	1 pièce
034809	noir mat lacqué (RAL 9005)	2600 mm	1 pièce

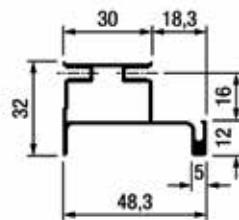

**Profil vertical Gola: côté**

- 1 pièce = 2600 mm

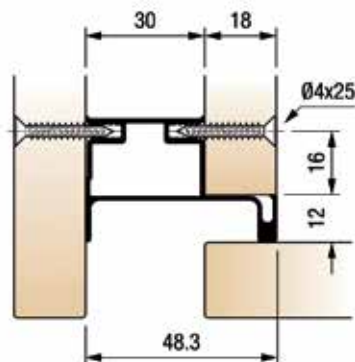

N° de com.	Finition	Longueur	Unité de com.
034812	aluminium anodisé	2600 mm	1 pièce
034815	anthracite lacqué	2600 mm	1 pièce
034814	blanc mat lacqué (RAL 9003)	2600 mm	1 pièce
034813	noir mat lacqué (RAL 9005)	2600 mm	1 pièce

PROFILS-POIGNÉE L

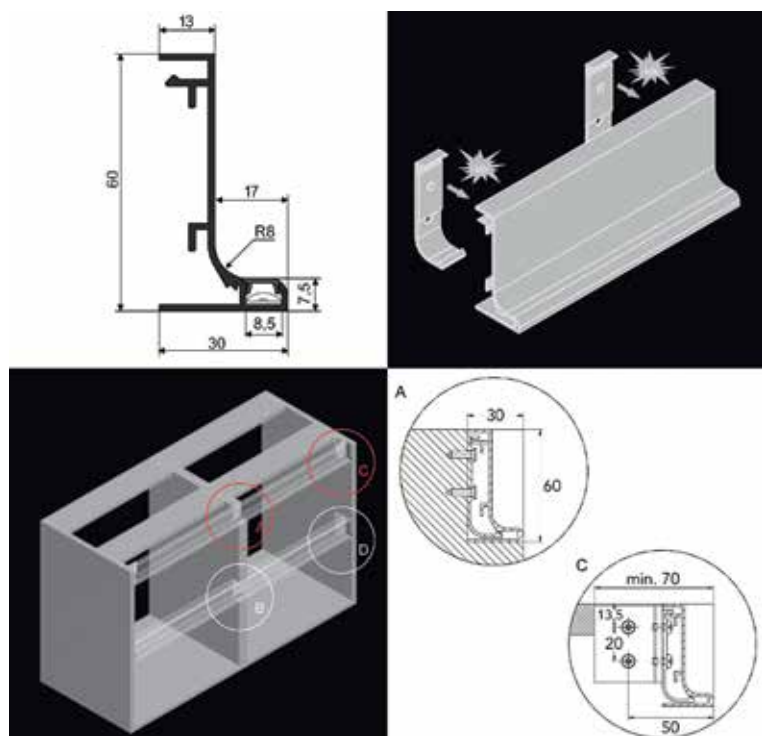

**Profil-poignée L avec rainure pour bande Led**

- avec rainure pour coller une bande Led  
 - profil diffuseur opale, clips et embouts à commander séparément (voir suivant)

- pour la bande Led: voir éclairages Led

- 1 pièce = 3500 mm

N° de com.	Finition	Description	Longueur	Unité de com.
047722	inox look	profil-poignée L Led	3500 mm	1 pièce

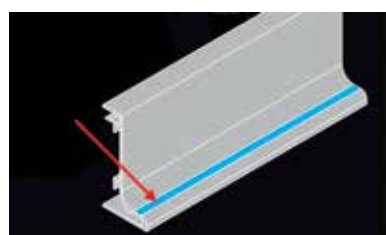

**Profil diffuseur opale pour profil-poignée L avec rainure pour bande Led**

- 1 pièce = 3500 mm

N° de com.	Finition	Longueur	Unité de com.
047729	satiné	3500 mm	1 pièce
047728	blanc	3500 mm	1 pièce



**Clips pour profils-poignée L et L Led**

- pour profils-poignée L et L Led

N° de com.	Finition	Description	Unité de com.
047660	aluminium	clip pour profils-poignée L et L Led	1 pièce
047725	aluminium	clip coin gauche pour profils-poignée L et L Led	1 pièce
047726	aluminium	clip coin droite pour profils-poignée L et L Led	1 pièce

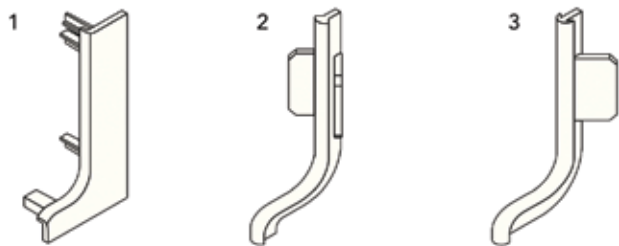

**Embouts et angles pour profils-poignée L et L Led**

- plastique

\* emballés dans un sachet (ex. si vous commandez 1 x 047665, vous recevrez 1 sachet de 10 paires)

N° de com.	Finition	Description	Numéro sur l'image	Unité de com.
<b>047665</b>	gris clair	embout pour profils-poignée L et L Led	1	1 kit
<b>047669</b>	gris clair	pièce d'angle intérieure pour profils-poignée L et L Led	2	1 kit
<b>047670</b>	gris clair	pièce d'angle extérieure pour profils-poignée L et L Led	3	1 kit

PROFILS-POIGNÉE C

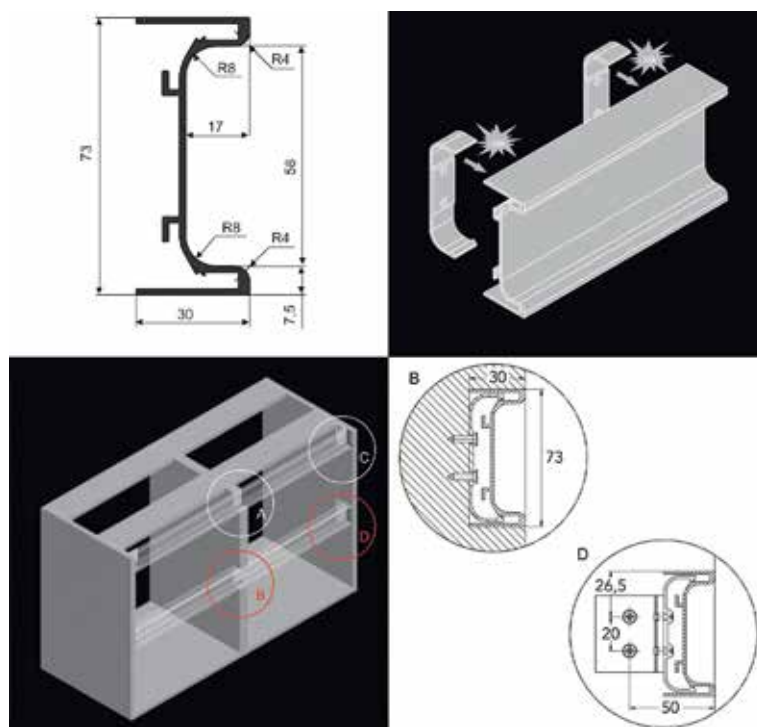

**Profil-poignée C**

- clips et embouts à commander séparément (voir suivant)

- 1 pièce = 3500 mm

N° de com.	Finition	Description	Longueur	Unité de com.
047661	aluminium	profil-poignée C	3500 mm	1 pièce

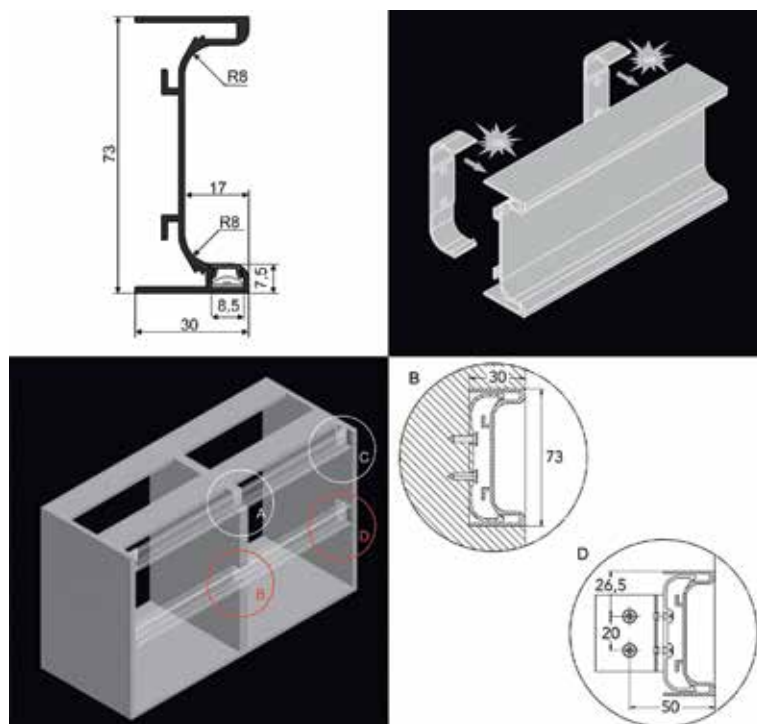

**Profil-poignée C avec rainure pour bande Led**

- avec rainure pour coller une bande Led  
- profil diffuseur opale, clips et embouts à commander séparément (voir suivant)

- pour la bande Led: voir éclairages Led

- 1 pièce = 3500 mm

N° de com.	Finition	Description	Longueur	Unité de com.
047723	aluminium	profil-poignée C Led	3500 mm	1 pièce
047724	inox look	profil-poignée C Led	3500 mm	1 pièce

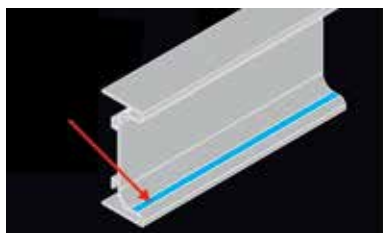

**Profil diffuseur opale pour profil-poignée C avec rainure pour bande Led**  
- 1 pièce = 3500 mm

N° de com.	Finition	Longueur	Unité de com.
047729	satiné	3500 mm	1 pièce
047728	blanc	3500 mm	1 pièce



**Clips pour profils-poignée C et C Led**  
- pour profils-poignée C et C Led  
- clip-coin reversible gauche/droite

N° de com.	Finition	Description	Unité de com.
047727	aluminium	clip coin pour profils-poignée C et C Led (reversible)	1 pièce

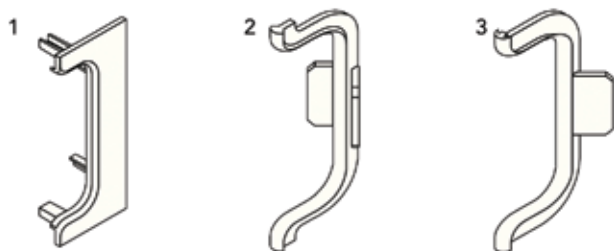

**Embouts et angles pour profils-poignée C et C Led**

- plastique  
\* emballés dans un sachet (ex. si vous commandez 1 x 047664, vous recevrez 1 sachet de 20 pièces)

N° de com.	Finition	Description	Numéro sur l'image	Unité de com.
047664	gris clair	embout pour profils-poignée C et C Led	1	1 kit
047667	gris clair	pièce d'angle intérieure pour profils-poignée C et C Led	2	1 kit
047668	gris clair	pièce d'angle extérieure pour profils-poignée C et C Led	3	1 kit

## POIGNÉES ET CHARNIÈRES DE PORTE

## POIGNÉES DE PORTE HDD

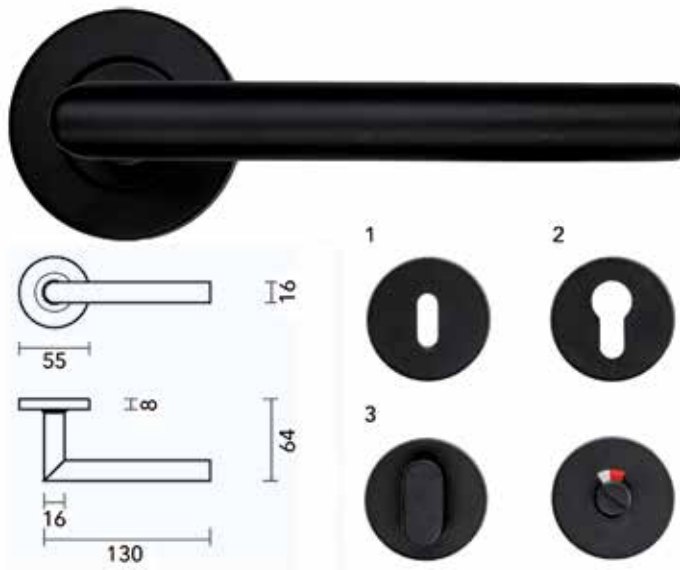
**Poignée de porte Pro I-shape Ø 16 mm**

- matière première: inox AISI 304
- double ressort
- fixation vis à travers (vis à travers inclus)
- finition: peinture en poudre noir mat
- épaisseur tube: 1 mm

N° de com.	Finition	Description	Unité de com.
016020	noir mat	2 poignées porte avec 2 rosaces pour porte intérieure (1)	1 paire
016021	noir mat	2 poignées porte avec 2 rosaces pour serrure à cylindre (2)	1 paire
016023	noir mat	2 poignées porte avec kit wc (3)	1 paire
016022	noir mat	2 poignées porte sans rosaces	1 paire

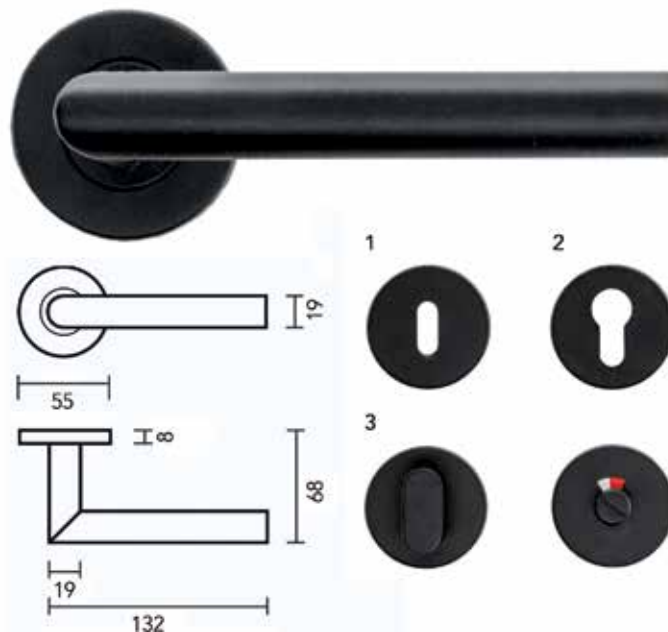
**Poignée de porte Pro I-shape Ø 19 mm**

- matière première: inox AISI 304
- double ressort
- fixation vis à travers (vis à travers inclus)
- finition: peinture en poudre noir mat
- épaisseur tube: 1 mm

N° de com.	Finition	Description	Unité de com.
016024	noir mat	2 poignées porte avec 2 rosaces pour porte intérieure (1)	1 paire
016025	noir mat	2 poignées porte avec 2 rosaces pour serrure à cylindre (2)	1 paire
016027	noir mat	2 poignées porte avec kit wc (3)	1 paire
016026	noir mat	2 poignées porte sans rosaces	1 paire



**Poignée de porte Pro L-shape Ø 16 mm**

- matière première: inox AISI 304
- double ressort
- fixation vis à travers (vis à travers inclus)
- finition: peinture en poudre noir mat
- épaisseur tube: 1 mm

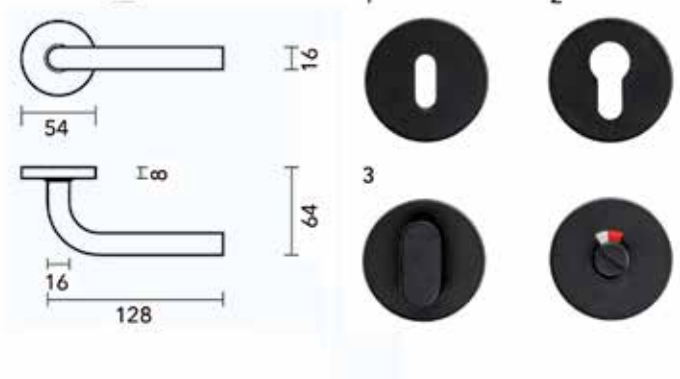

N° de com.	Finition	Description	Unité de com.
016883	bronze mat	2 poignées porte avec 2 rosaces pour porte intérieure (1)	1 paire
016884	bronze mat	2 poignées porte avec 2 rosaces pour serrure à cylindre (2)	1 paire
016886	bronze mat	2 poignées porte avec kit wc (3)	1 paire
016885	bronze mat	2 poignées porte sans rosaces	1 paire
016032	noir mat	2 poignées porte avec 2 rosaces pour porte intérieure (1)	1 paire
016033	noir mat	2 poignées porte avec 2 rosaces pour serrure à cylindre (2)	1 paire
016035	noir mat	2 poignées porte avec kit wc (3)	1 paire
016034	noir mat	2 poignées porte sans rosaces	1 paire



**Poignée de porte L-shape Ø 19 mm**

- matière première: inox AISI 304
- double ressort
- fixation vis à travers (vis à travers inclus)
- finition: peinture en poudre noir mat
- épaisseur tube: 1 mm

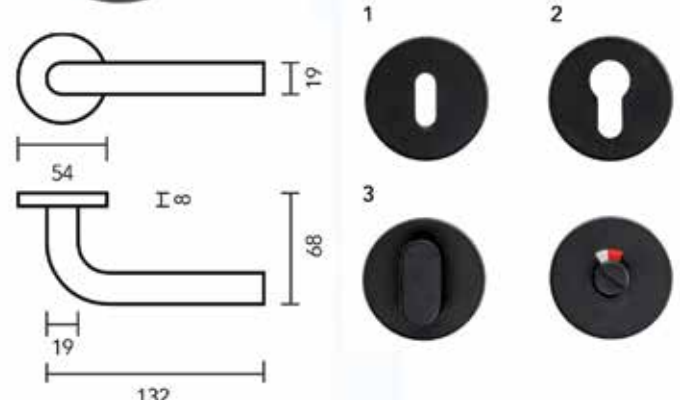

N° de com.	Finition	Description	Unité de com.
016036	noir mat	2 poignées porte avec 2 rosaces pour porte intérieure (1)	1 paire
016037	noir mat	2 poignées porte avec 2 rosaces pour serrure à cylindre (2)	1 paire
016039	noir mat	2 poignées porte avec kit wc (3)	1 paire
016038	noir mat	2 poignées porte sans rosaces	1 paire

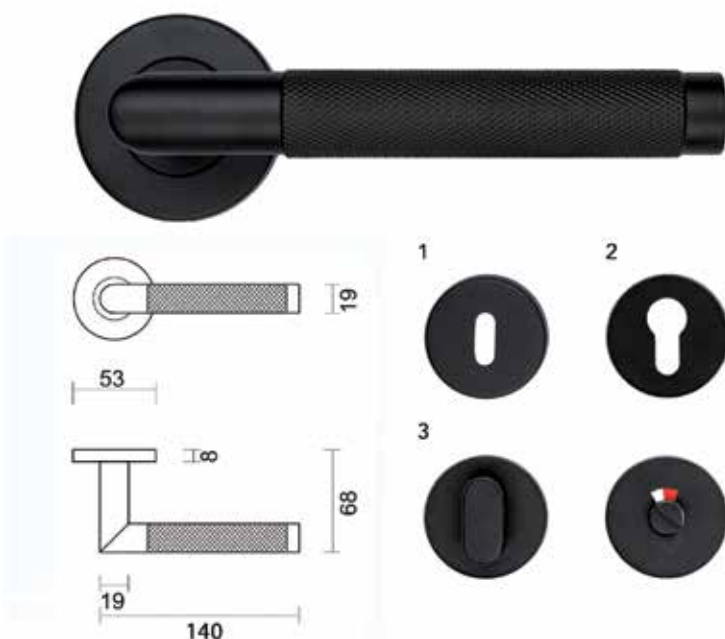
**Poignée de porte Hashtag**

- matière première: inox AISI 304
- double ressort
- fixation vis à travers (vis à travers inclus)
- finition: peinture en poudre noir mat

N° de com.	Finition	Description	Unité de com.
016879	noir mat	2 poignées porte avec 2 rosaces pour porte intérieure (1)	1 paire
016880	noir mat	2 poignées porte avec 2 rosaces pour serrure à cylindre (2)	1 paire
016882	noir mat	2 poignées porte avec kit wc (3)	1 paire
016881	noir mat	2 poignées porte sans rosaces	1 paire

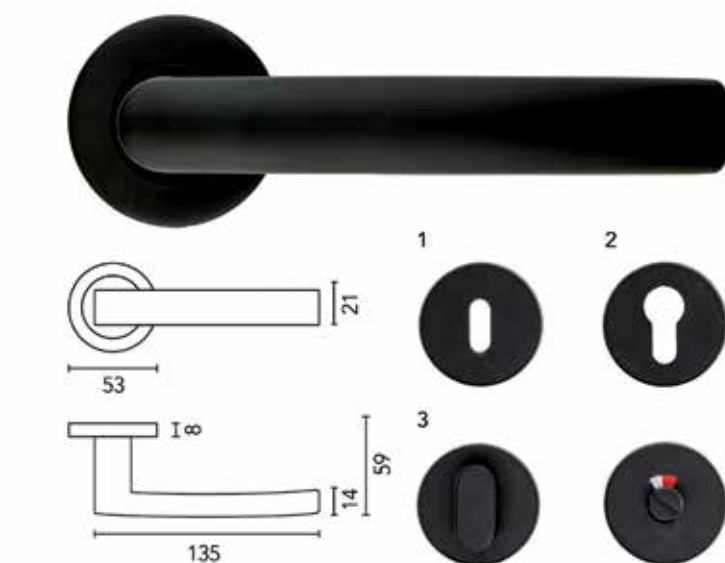
**Poignée de porte Pro Oval C-shape**

- matière première: inox AISI 304
- fixation vis à travers (vis à travers inclus)
- finition: peinture en poudre noir mat

N° de com.	Finition	Description	Unité de com.
016044	noir mat	2 poignées porte avec 2 rosaces pour porte intérieure (1)	1 paire
016045	noir mat	2 poignées porte avec 2 rosaces pour serrure à cylindre (2)	1 paire
016047	noir mat	2 poignées porte avec kit wc (3)	1 paire
016046	noir mat	2 poignées porte sans rosaces	1 paire

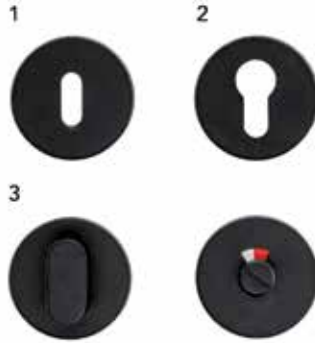
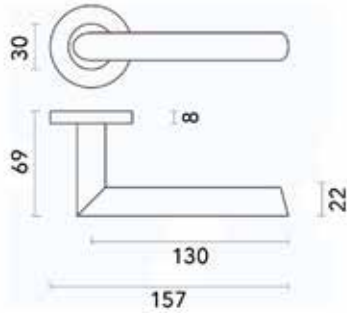

**Poignée de porte Pro Ellips**

- matière première: inox AISI 304
- double ressort
- fixation vis à travers (vis à travers inclus)
- finition: peinture en poudre noir mat
- épaisseur tube: 1 mm

N° de com.	Finition	Description	Unité de com.
016008	noir mat	2 poignées porte avec 2 rosaces pour porte intérieure (1)	1 paire
016009	noir mat	2 poignées porte avec 2 rosaces pour serrure à cylindre (2)	1 paire
016011	noir mat	2 poignées porte avec kit wc (3)	1 paire
016010	noir mat	2 poignées porte sans rosaces	1 paire

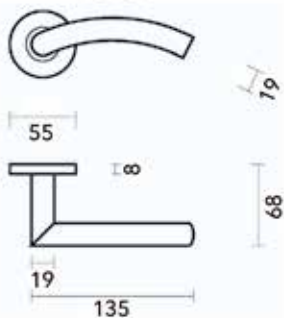

**Poignée de porte Pro GI-shape**

- matière première: inox AISI 304
- double ressort
- fixation vis à travers (vis à travers inclus)
- finition: peinture en poudre noir mat
- épaisseur tube: 1 mm

N° de com.	Finition	Description	Unité de com.
016012	noir mat	2 poignées porte avec 2 rosaces pour porte intérieure (1)	1 paire
016013	noir mat	2 poignées porte avec 2 rosaces pour serrure à cylindre (2)	1 paire
016015	noir mat	2 poignées porte avec kit wc (3)	1 paire
016014	noir mat	2 poignées porte sans rosaces	1 paire

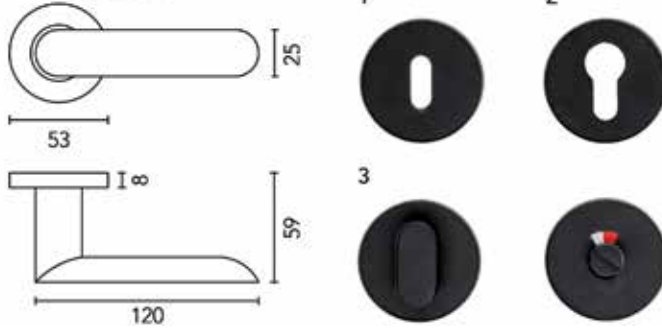

- Poignée de porte Pro Space**
- matière première: inox AISI 304
  - double ressort
  - fixation vis à travers (vis à travers inclus)
  - finition: peinture en poudre noir mat
  - épaisseur tube: 1 mm

N° de com.	Finition	Description	Unité de com.
016064	noir mat	2 poignées porte avec 2 rosaces pour porte intérieure (1)	1 paire
016065	noir mat	2 poignées porte avec 2 rosaces pour serrure cylindre (2)	1 paire
016067	noir mat	2 poignées porte avec kit wc (3)	1 paire
016066	noir mat	2 poignées porte sans rosaces	1 paire

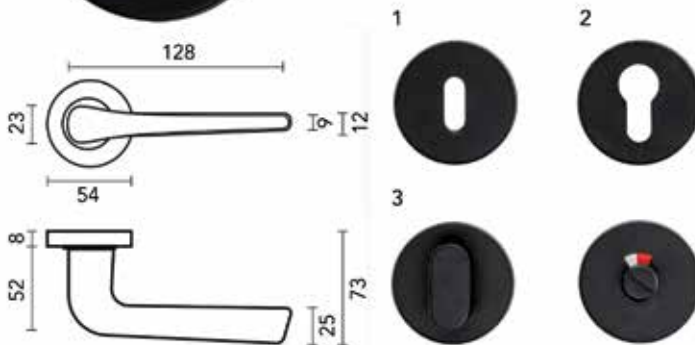

- Poignée de porte Pro Sipora**
- matière première: inox AISI 304
  - double ressort
  - finition: peinture en poudre noir mat

N° de com.	Finition	Description	Unité de com.
016060	noir mat	2 poignées porte avec 2 rosaces pour porte intérieure (1)	1 paire
016061	noir mat	2 poignées porte avec 2 rosaces pour serrure à cylindre (2)	1 paire
016063	noir mat	2 poignées porte avec kit wc (3)	1 paire
016062	noir mat	2 poignées porte sans rosaces	1 paire



**Poignée de porte Pro Da Vinci**

- matière première: laiton
- pas de ressort
- pas de montage avec vis à travers possible
- finition: peinture en poudre noir mat

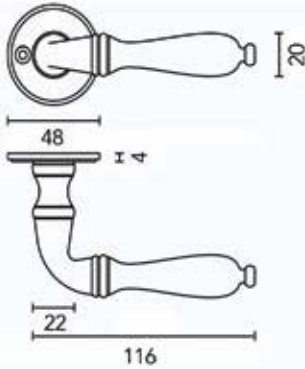

N° de com.	Finition	Description	Unité de com.
016004	noir mat	2 poignées porte avec 2 rosaces pour porte intérieure (1)	1 paire
016005	noir mat	2 poignées porte avec 2 rosaces pour serrure à cylindre (2)	1 paire
016007	noir mat	2 poignées porte avec kit wc (3)	1 paire
016006	noir mat	2 poignées porte sans rosaces	1 paire



**Poignée de porte Pro Gretana**

- matière première: laiton
- pas de ressort
- pas de montage avec vis à travers possible
- finition: peinture en poudre noir mat

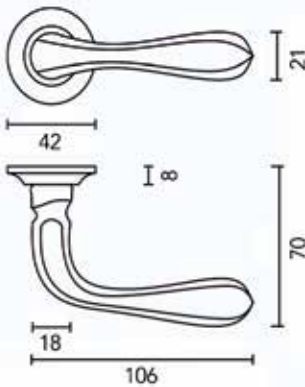

N° de com.	Finition	Description	Unité de com.
016016	noir mat	2 poignées porte avec 2 rosaces pour porte intérieure (1)	1 paire
016017	noir mat	2 poignées porte avec 2 rosaces pour serrure à cylindre (2)	1 paire
016019	noir mat	2 poignées porte avec kit wc (3)	1 paire
016018	noir mat	2 poignées porte sans rosaces	1 paire

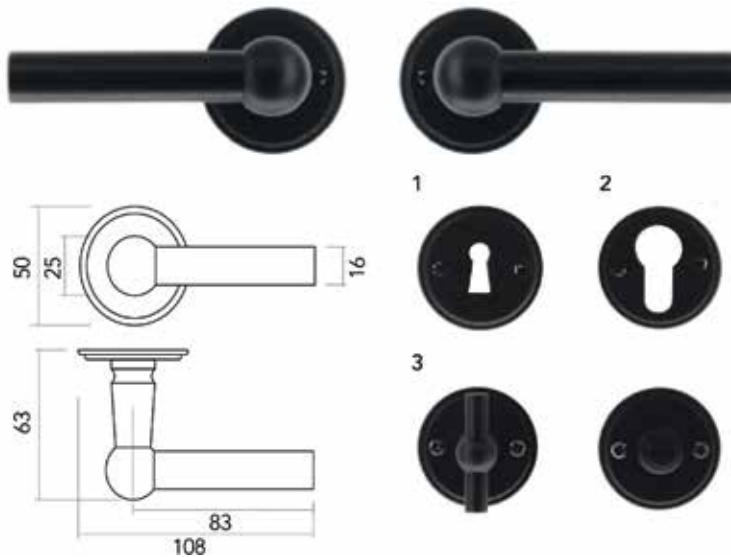

**Poignée de porte Pro Petana L + L**

- matière première: laiton
- pas de ressort
- pas de montage avec vis à travers possible
- finition: peinture en poudre noir mat

N° de com.	Finition	Description	Unité de com.
016048	noir mat	2 poignées porte avec 2 rosaces pour porte intérieure (1)	1 paire
016049	noir mat	2 poignées porte avec 2 rosaces pour serrure à cylindre (2)	1 paire
016051	noir mat	2 poignées porte avec kit wc (3)	1 paire
016050	noir mat	2 poignées porte sans rosaces	1 paire

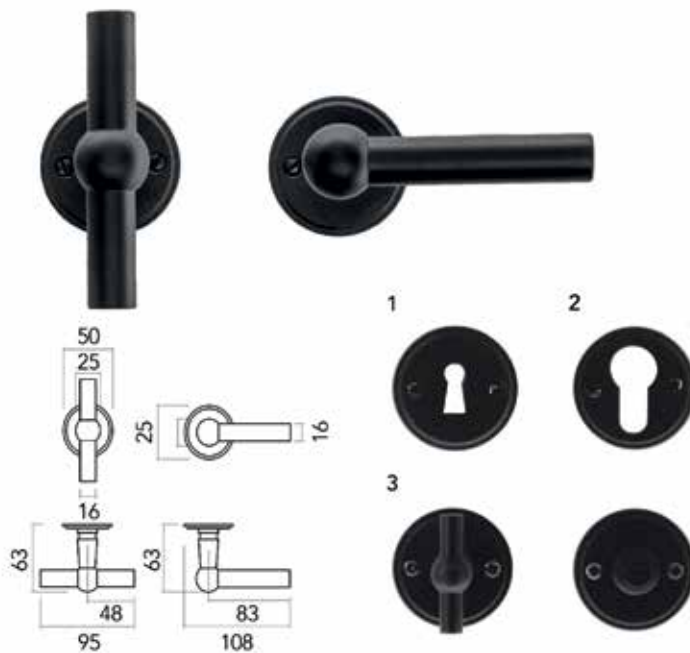

**Poignée de porte Pro Petana T + L**

- matière première: laiton
- pas de ressort
- pas de montage avec vis à travers possible
- finition: peinture en poudre noir mat

N° de com.	Finition	Description	Unité de com.
016052	noir mat	2 poignées porte avec 2 rosaces pour porte intérieure (1)	1 paire
016053	noir mat	2 poignées porte avec 2 rosaces pour serrure à cylindre (2)	1 paire
016055	noir mat	2 poignées porte avec kit wc (3)	1 paire
016054	noir mat	2 poignées porte sans rosaces	1 paire

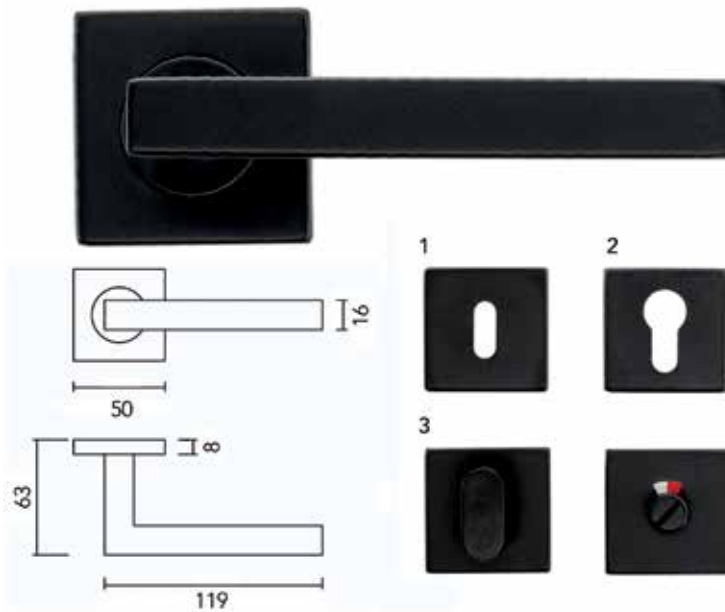

**Poignée de porte Pro Kubic shape**

- matière première: inox AISI 304
- double ressort
- fixation vis à travers (vis à travers inclus)
- finition: peinture en poudre noir mat
- épaisseur tube: 1 mm

N° de com.	Finition	Description	Unité de com.
016887	bronze mat	2 poignées porte avec 2 rosaces pour porte intérieure (1)	1 paire
016888	bronze mat	2 poignées porte avec 2 rosaces pour serrure à cylindre (2)	1 paire
016890	bronze mat	2 poignées porte avec kit wc (3)	1 paire
016889	bronze mat	2 poignées porte sans rosaces	1 paire
016028	noir mat	2 poignées porte avec 2 rosaces pour porte intérieure (1)	1 paire
016029	noir mat	2 poignées porte avec 2 rosaces pour serrure à cylindre (2)	1 paire
016031	noir mat	2 poignées porte avec kit wc (3)	1 paire
016030	noir mat	2 poignées porte sans rosaces	1 paire

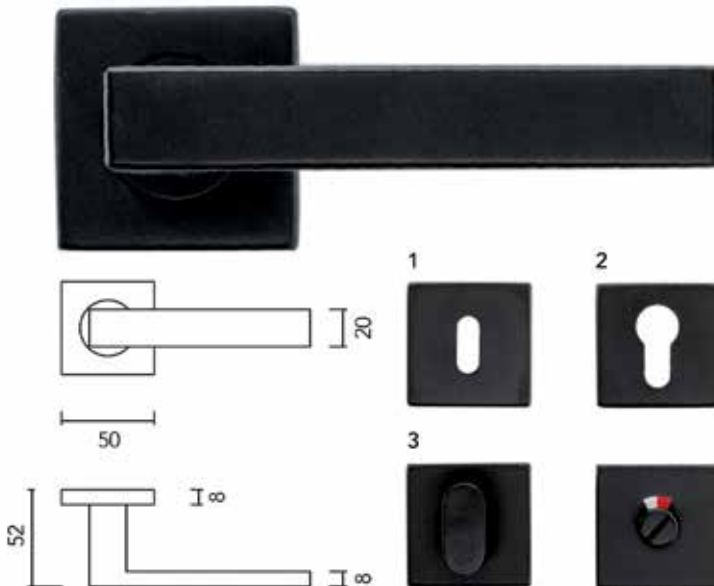

**Poignée de porte Pro Cosmic**

- matière première: inox AISI 304
- double ressort
- fixation vis à travers (vis à travers inclus)
- fixation rosace: 2 x 4 clips
- finition: peinture en poudre noir mat

N° de com.	Finition	Description	Unité de com.
016891	bronze mat	2 poignées porte avec 2 rosaces pour porte intérieure (1)	1 paire
016892	bronze mat	2 poignées porte avec 2 rosaces pour serrure à cylindre (2)	1 paire
016894	bronze mat	2 poignées porte avec kit wc (3)	1 paire
016893	bronze mat	2 poignées porte sans rosaces	1 paire
016000	noir mat	2 poignées porte avec 2 rosaces pour porte intérieure (1)	1 paire
016001	noir mat	2 poignées porte avec 2 rosaces pour serrure à cylindre (2)	1 paire
016003	noir mat	2 poignées porte avec kit wc (3)	1 paire
016002	noir mat	2 poignées porte sans rosaces	1 paire

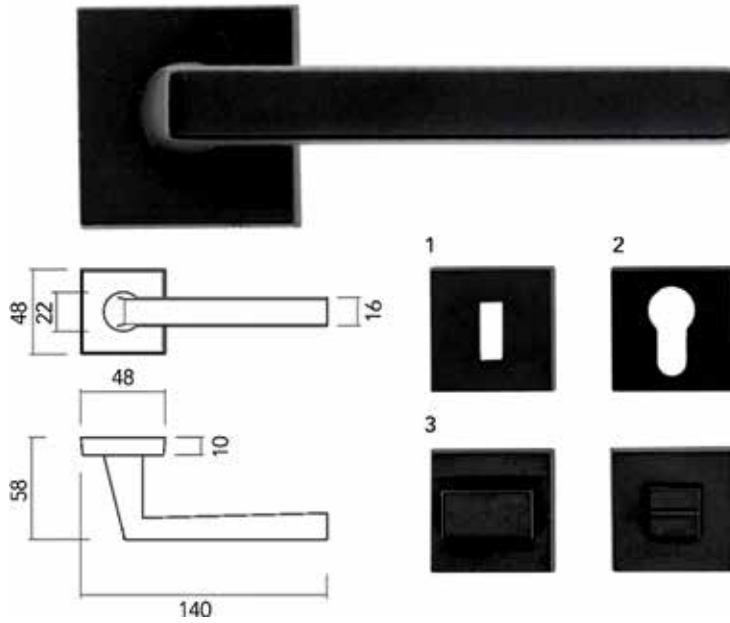

**Poignée de porte Pro Luis**

- matière première: zamac
- double ressort
- pas de montage avec vis à travers possible
- finition: peinture en poudre noir mat

N° de com.	Finition	Description	Unité de com.
016040	noir mat	2 poignées porte avec 2 rosaces pour porte intérieure (1)	1 paire
016041	noir mat	2 poignées porte avec 2 rosaces pour serrure à cylindre (2)	1 paire
016043	noir mat	2 poignées porte avec kit wc (3)	1 paire
016042	noir mat	2 poignées porte sans rosaces	1 paire

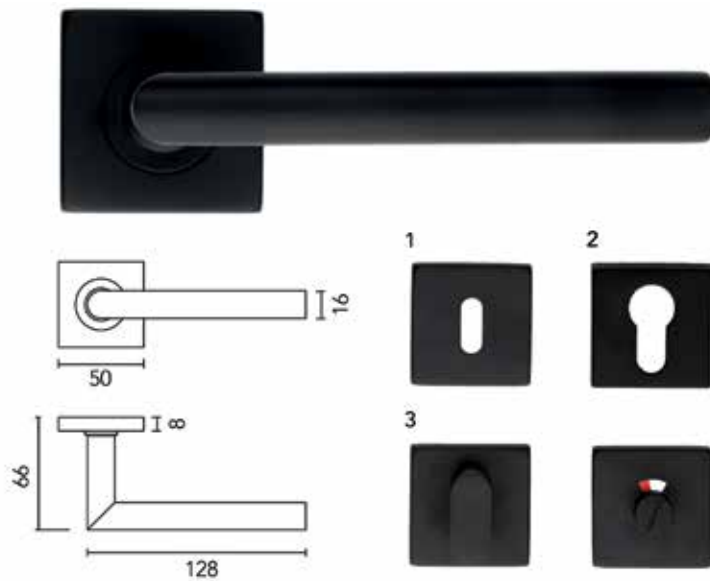

**Poignée de porte Pro Square I-shape: Ø 16 mm**

- matière première: inox AISI 304
- double ressort
- fixation vis à travers (vis à travers inclus)
- finition: peinture en poudre noir mat
- épaisseur tube: 1 mm

N° de com.	Finition	Description	Unité de com.
016068	noir mat	2 poignées porte avec 2 rosaces pour porte intérieure (1)	1 paire
016069	noir mat	2 poignées porte avec 2 rosaces pour serrure à cylindre (2)	1 paire
016071	noir mat	2 poignées porte avec kit wc (3)	1 paire
016070	noir mat	2 poignées porte sans rosaces	1 paire



**Poignée de porte Pro Square I-shape: Ø 19 mm**

- matière première: inox AISI 304
- double ressort
- fixation vis à travers (vis à travers inclus)
- finition: peinture en poudre noir mat
- épaisseur tube: 1 mm

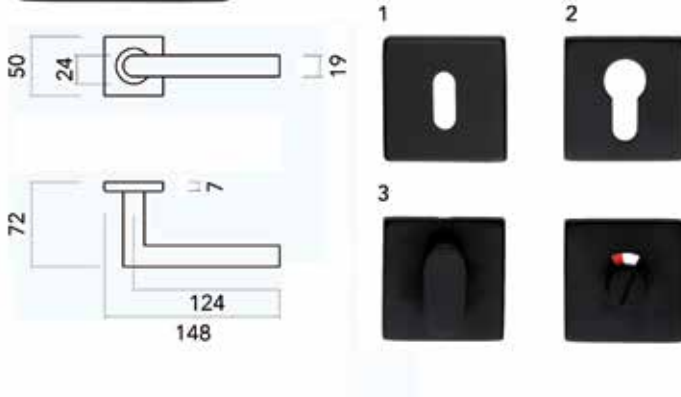

N° de com.	Finition	Description	Unité de com.
016072	noir mat	2 poignées porte avec 2 rosaces pour porte intérieure (1)	1 paire
016073	noir mat	2 poignées porte avec 2 rosaces pour serrure à cylindre (2)	1 paire
016075	noir mat	2 poignées porte avec kit wc (3)	1 paire
016074	noir mat	2 poignées porte sans rosaces	1 paire



**Poignée de porte Pro X-Treme**

- matière première: zamac
- double ressort
- vis à travers inox (vis à travers inclus)
- finition: peinture en poudre noir mat

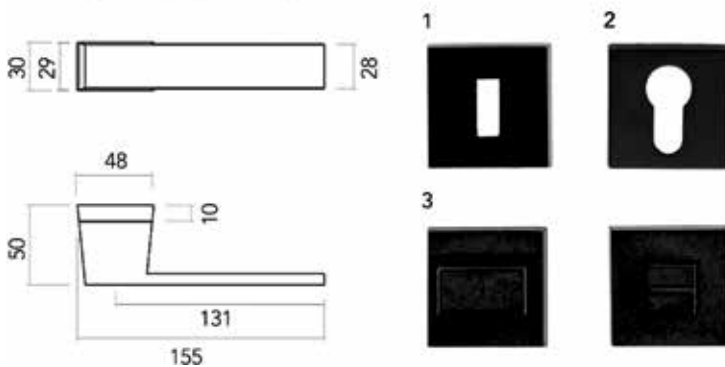

N° de com.	Finition	Description	Unité de com.
016076	noir mat	2 poignées porte avec 2 rosaces pour porte intérieure (1)	1 paire
016077	noir mat	2 poignées porte avec 2 rosaces pour serrure à cylindre (2)	1 paire
016079	noir mat	2 poignées porte avec kit wc (3)	1 paire
016078	noir mat	2 poignées porte sans rosaces	1 paire

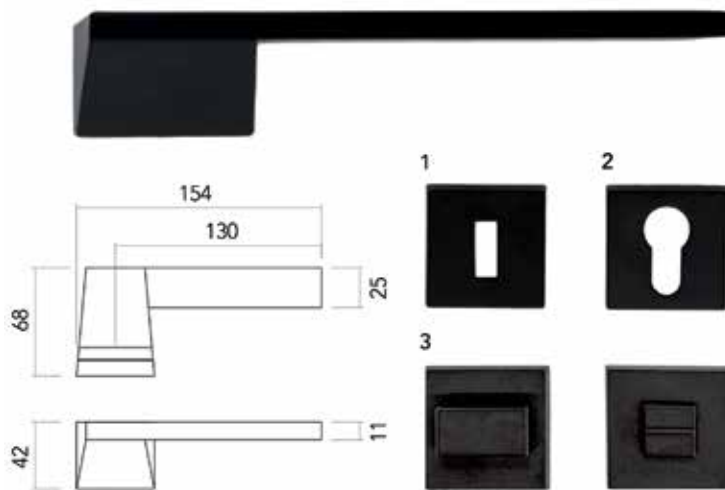
**Poignée de porte Pro Seliz**

- matière première: zamac
- double ressort
- vis à travers inox (vis à travers inclus)
- finition: peinture en poudre noir mat

N° de com.	Finition	Description	Unité de com.
016056	noir mat	2 poignées porte avec 2 rosaces pour porte intérieure (1)	1 paire
016057	noir mat	2 poignées porte avec 2 rosaces pour serrure à cylindre (2)	1 paire
016059	noir mat	2 poignées porte avec kit wc (3)	1 paire
016058	noir mat	2 poignées porte sans rosaces	1 paire

POIGNÉES DE PORTES PURE



**Poignée Pure type PH1920 /QU**  
- par paire

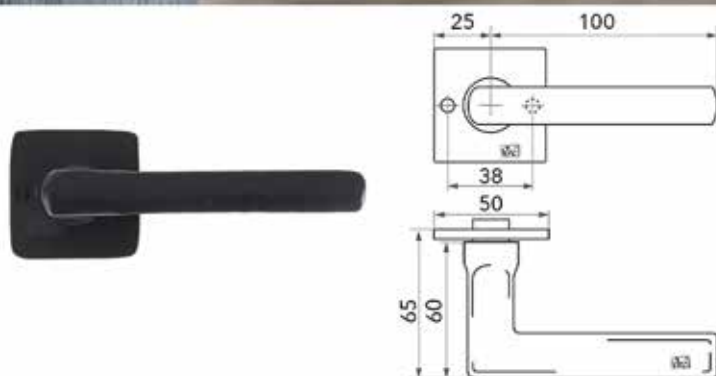

N° de com.	Finition	-	Unité de com.
058808	fer vieilli	-	1 paire



**Poignée Pure type PHTL'T+L' 50-R**  
- par paire

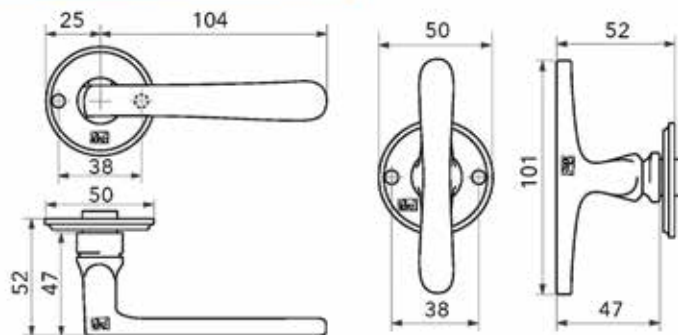

N° de com.	Finition	-	Unité de com.
059095	fer vieilli	-	1 paire



**Poignée Pure type PHL'L+L' 50R**  
- par paire

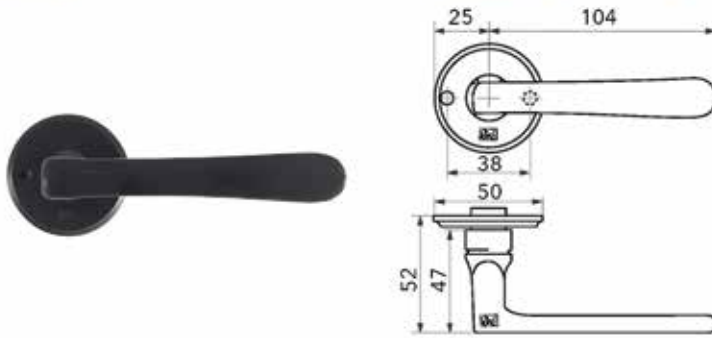

N° de com.	Finition	-	Unité de com.
059105	fer vieilli	-	1 paire



**Poignée Pure type PH1928 /QU**  
- par paire

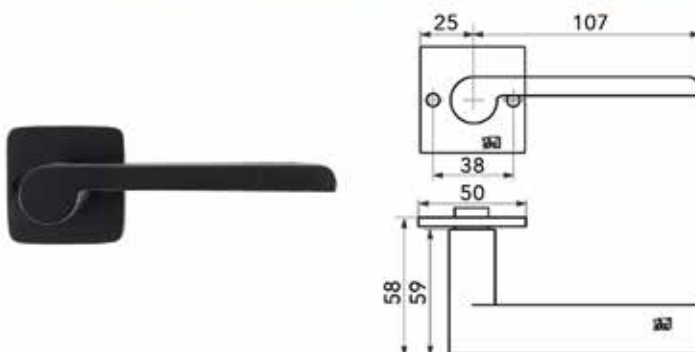

N° de com.	Finition	-	Unité de com.
059110	fer vieilli	-	1 paire



**Poignée Pure type PHT'T+T' 50-R**

- par paire

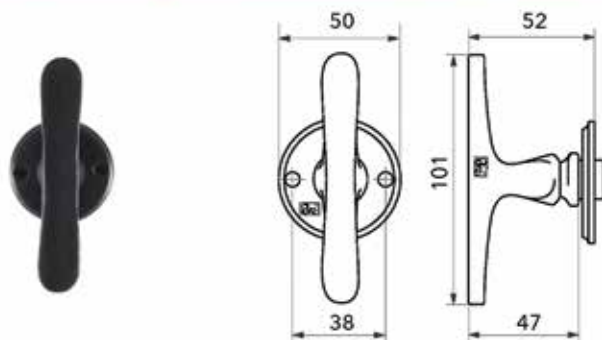

N° de com.	Finition	-	Unité de com.
059374	fer vieilli	-	1 paire

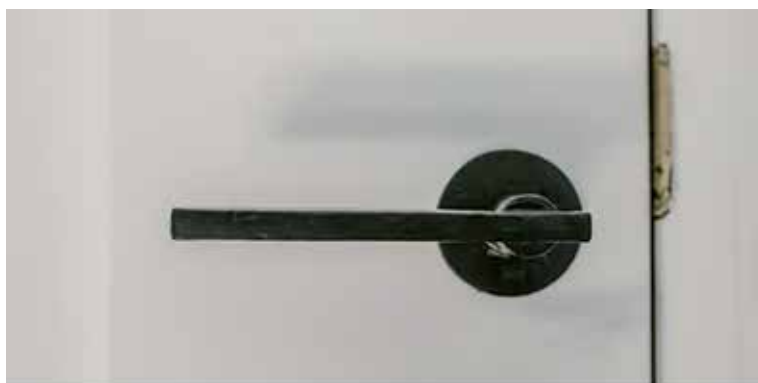

**Poignée Pure type PH2017 /50F**

- par paire

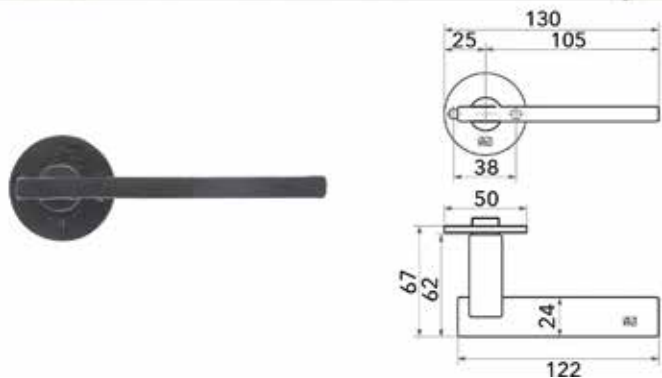

N° de com.	Finition	-	Unité de com.
060552	fer vieilli	-	1 paire



**Poignée Pure type PH1928 /50F**  
- par paire



N° de com.	Finition	-	Unité de com.
060794	fer vieilli	-	1 paire

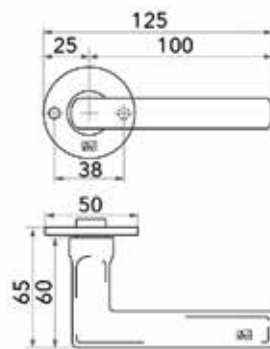

**Poignée Pure type PH1920 /50F**  
- par paire

N° de com.	Finition	-	Unité de com.
060810	fer vieilli	-	1 paire

## PAUMELLES

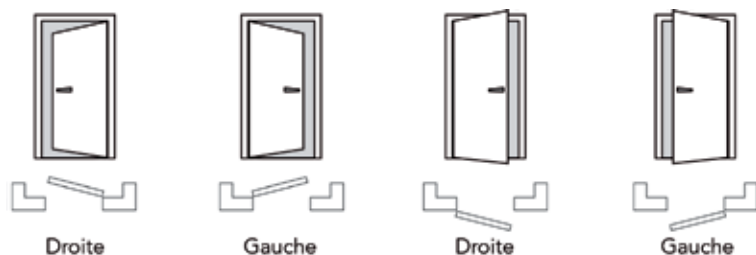

Nous mentionnons le sens de rotation Belge, qui est également utilisé en France. Aux Pays-Bas et en Allemagne, ils utilisent la norme DIN (l'inverse). Consultez le dessin du haut et vous recevrez ainsi les paumelles correctes.

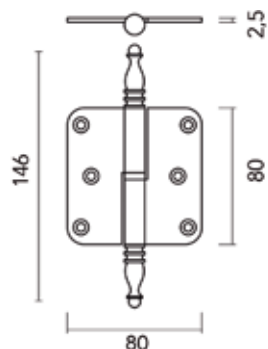

**Paumelle Vase**

N° de com.	Finition	Gauche/droite	Mesures	Unité de com.
016122	noir mat	gauche (Belge)	146/80 x 80 x 2,5 mm	1 pièce
016123	noir mat	droite (Belge)	146/80 x 80 x 2,5 mm	1 pièce

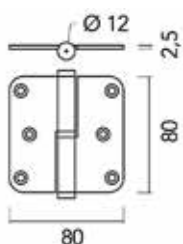

**Paumelle 80 x 80**

N° de com.	Finition	Gauche/droite	Mesures	Unité de com.
016124	noir mat	gauche (Belge)	80 x 80 x 2,5 mm	1 pièce
016125	noir mat	droite (Belge)	80 x 80 x 2,5 mm	1 pièce

PAUMELLES INVISIBLES

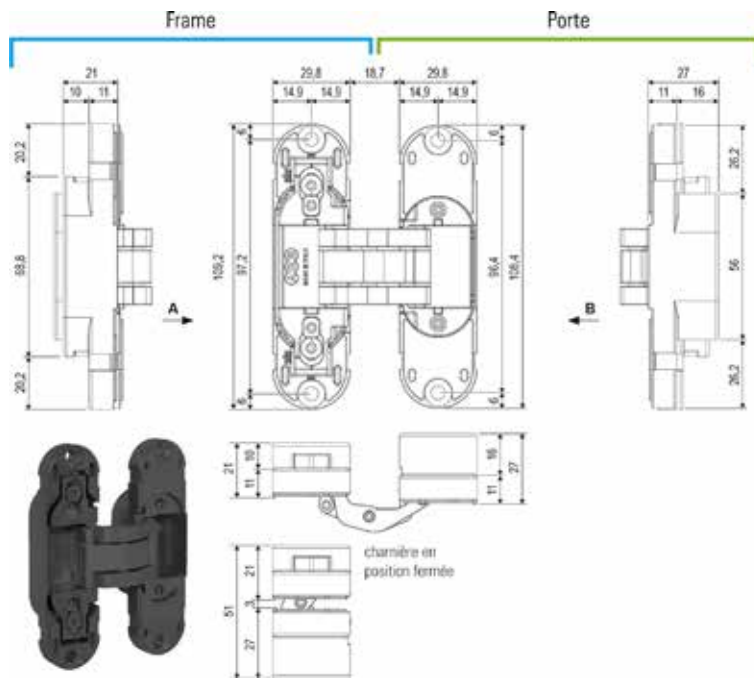

**Paumelle AGB eclipse 2.2**

- réglage 3D
- pour cadre bloc
- pour portes en bois
- charge: 30 kg par paumelle

N° de com.	Finition	-	Unité de com.
016292	noir	-	1 pièce



**Paumelle AGB Eclipse 3**

- réglage 3D
- pour ouverture inverse et cadre bloc normal
- pour portes en bois et aluminium
- charge: 20 kg par charnière

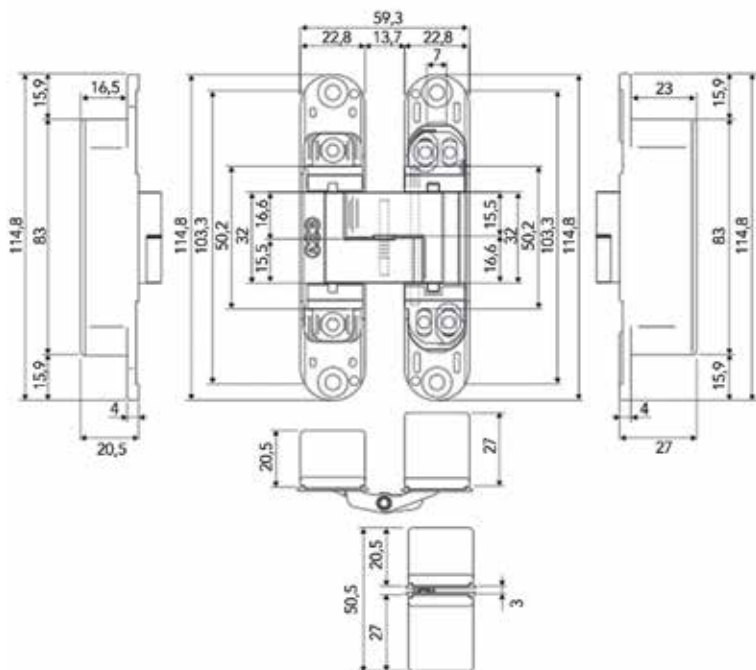

N° de com.	Finition	-	Unité de com.
016121	noir	-	1 pièce

QUINCAILLERIE DÉCORATIVE DIVERS

ARRÊTS DE PORTE

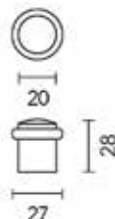

**Arrêt de porte type Bora**

- matière première: inox AISI 304

N° de com.	Finition	-	Unité de com.
016114	noir mat	-	1 pièce

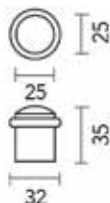

**Arrêt de porte type Massif**

- matière première: inox AISI 304

- vis et cheville inclus

N° de com.	Finition	-	Unité de com.
016874	inox brossée	-	1 pièce
016118	noir mat	-	1 pièce



**Arrêt de porte type Retro**

- matière première: laiton

N° de com.	Finition	-	Unité de com.
016119	noir mat	-	1 pièce

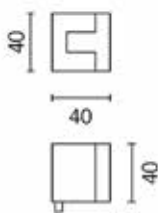

**Arrêt de porte type Carré**

- matière première: inox AISI 304

- vis et cheville inclus

N° de com.	Finition	-	Unité de com.
016875	inox brossée	-	1 pièce
016115	noir mat	-	1 pièce

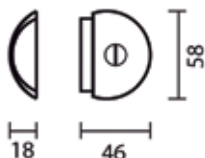

**Arrêt de porte type Demie lune**

- matière première: inox AISI 304

- hauteur: 18 mm

N° de com.	Finition	-	Unité de com.
016116	noir mat	-	1 pièce



**Arrêt de porte type Demie lune**

- matière première: inox AISI 304  
- hauteur: 29 mm

N° de com.	Finition	-	Unité de com.
016117	noir mat	-	1 pièce



**Arrêt de porte**

- matière première: inox AISI 304

N° de com.	Finition	Poids	Unité de com.
016113	noir mat	1,25 kg	1 pièce

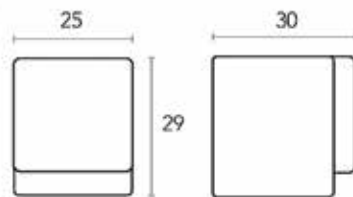

**Arrêt de porte type FP05**

- vis, cheville et autocollant 3M pour fixation inclus

N° de com.	Finition	Largeur	Profondeur	Hauteur	Unité de com.
060464	chromé mat	25 mm	30 mm	29 mm	1 pièce

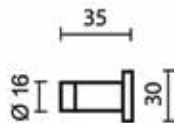

**Arrêt de porte mural**

- matière première: inox AISI 304

N° de com.	Finition	-	Unité de com.
016111	noir mat	-	1 pièce

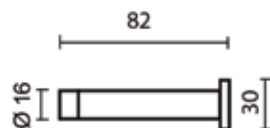

**Arrêt de porte mural**

- matière première: inox AISI 304

N° de com.	Finition	-	Unité de com.
016112	noir mat	-	1 pièce

## PORTEMANTEAUX



Portemanteau Pure Plus

N° de com.	Finition	-	Unité de com.
058799	fer vieilli	-	1 pièce



Crochet mural Pure Plus type PT-Q

N° de com.	Finition	Plaque de montage	Profondeur	Unité de com.
059887	fer vieilli	50 x 50 mm	-	1 pièce



Crochet mural Pure Plus type PT-R

N° de com.	Finition	Plaque de montage	Profondeur	Unité de com.
059981	fer vieilli	dia. 50 mm	40 mm	1 pièce



Crochet mural Pure Plus type PTT

N° de com.	Finition	Plaque de montage	Profondeur	Unité de com.
060611	fer vieilli	50 x 50 mm	40 mm	1 pièce



**Portemanteau type Diener S**

- portemanteau pour montage encastré

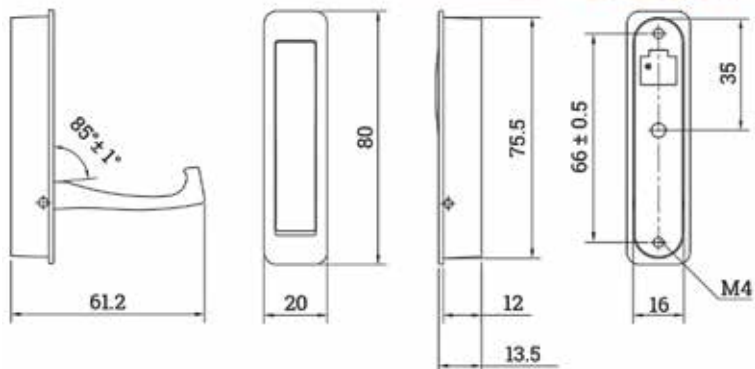

N° de com.	Finition	Hauteur	Largeur	Profondeur	Unité de com.
014052	inox look	80 mm	20 mm	13,5 mm	1 pièce



**Portemanteau type 32**

- avec porte-chapeau

N° de com.	Finition	Profondeur	Hauteur	Unité de com.
020242	aluminium	89 mm	127 mm	1 pièce
022536	noir	89 mm	127 mm	1 pièce



**Portemanteau type 33**

N° de com.	Finition	Profondeur	Hauteur	Unité de com.
020243	aluminium	55 mm	43 mm	1 pièce
020316	noir	55 mm	43 mm	1 pièce

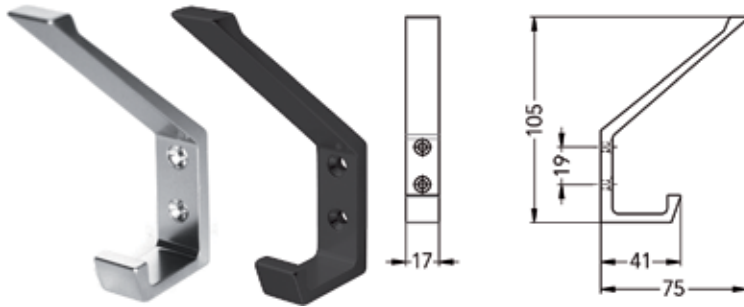

**Portemanteau type 138**  
- avec porte-chapeau

N° de com.	Finition	Profondeur	Hauteur	Unité de com.
020225	aluminium	75 mm	105 mm	1 pièce
020321	noir mat	75 mm	105 mm	1 pièce

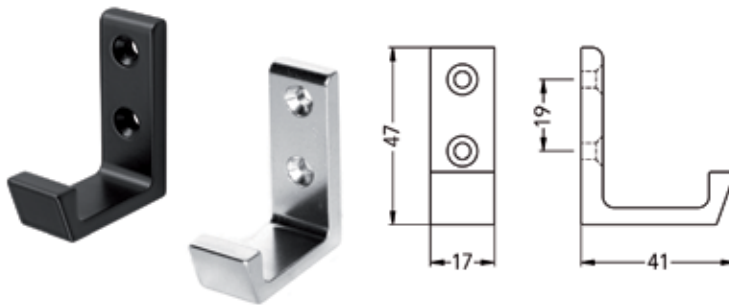

**Portemanteau type 139**

N° de com.	Finition	Profondeur	Hauteur	Unité de com.
020226	aluminium	41 mm	47 mm	1 pièce
020318	noir mat	41 mm	47 mm	1 pièce



**Portemanteau type 148**  
- avec porte-chapeau

N° de com.	Finition	Profondeur	Hauteur	Unité de com.
021814	aluminium	85 mm	135 mm	1 pièce



**Portemanteau type 149**

N° de com.	Finition	Profondeur	Hauteur	Unité de com.
021815	aluminium	50 mm	65 mm	1 pièce



Portemanteau type 129

N° de com.	Finition	Profondeur	Hauteur	Unité de com.
020320	aluminium	40 mm	55 mm	1 pièce
020319	noir mat	40 mm	55 mm	1 pièce



Portemanteau type 2860

N° de com.	Finition	Longueur	Largeur	Profondeur	Unité de com.
059147	chromé	56 mm	25 mm	29 mm	1 pièce
059148	chromé mat	56 mm	25 mm	29 mm	1 pièce
059146	inox look	56 mm	25 mm	29 mm	1 pièce



Portemanteaux simple

- zamak
- vis de fixation inclus

N° de com.	Finition	Largeur	Profondeur	Hauteur	Unité de com.
058311	inox look	12 mm	40 mm	40 mm	1 pièce
058309	blanc	12 mm	40 mm	40 mm	1 pièce
058310	noir	12 mm	40 mm	40 mm	1 pièce



Portemanteaux double

- zamak
- vis de fixation inclus

N° de com.	Finition	Largeur	Profondeur	Hauteur	Unité de com.
058308	inox look	52 mm	40 mm	40 mm	1 pièce
058306	blanc	52 mm	40 mm	40 mm	1 pièce
058307	noir	52 mm	40 mm	40 mm	1 pièce

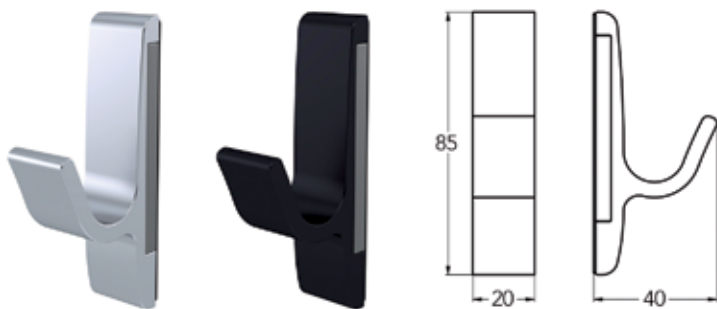

**Crochet magnétique type 0150**  
- montage sur une paroi en métal  
au moyen de l'aimant intégré

N° de com.	Finition	-	Unité de com.
022528	aluminium	-	1 pièce
022529	noir	-	1 pièce

PORTE-ESSUIES



**Mains courantes avec supports Pure Plus type PR**  
- crochets à commander séparément

N° de com.	Finition	Longueur	Diamètre	Hauteur	Unité de com.
058791	fer vieilli	1000 mm	14 mm	65 mm	1 kit
059869	fer vieilli	1000 mm	14 mm	150 mm	1 kit



**Support Pure Plus type PRst**  
- pour mains courantes type PR

N° de com.	Finition	Hauteur	Unité de com.
058803	fer vieilli	65 mm	1 pièce



**Crochet Pure Plus type PRh**  
- pour mains courantes type PR

N° de com.	Finition	Hauteur	Unité de com.
058793	fer vieilli	52 mm	1 pièce



**Mains courantes avec supports Pure Q**

- crochets à commander séparément
- tige rectangulaire

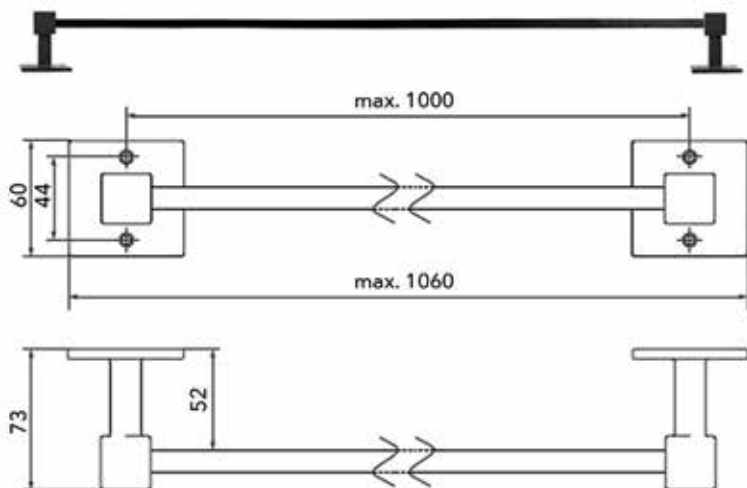

N° de com.	Finition	Longueur	Diamètre	Hauteur	Unité de com.
060450	fer vieilli	1000 mm	14 x 14 mm	70 mm	1 kit



**Support Pure Plus Q type PRst**

- pour mains courantes type Pure Plus Q

N° de com.	Finition	Hauteur	Unité de com.
060649	fer vieilli	70 mm	1 pièce



**Crochet Pure Plus Q type PRh**

- pour mains courantes Pure Plus Q

N° de com.	Finition	Hauteur	Unité de com.
060426	fer vieilli	50 mm	1 pièce

## ACCESSOIRES

## EMBASE FRONTAL

**Embase frontal**

- L'embase permet un montage frontal d'une poignée.  
Une poignée (longue) pourrait ainsi faire office de porte-essuie.

N° de com.	Finition	Largeur	Hauteur	Epaisseur	Entraxe	Unité de com.
059532	nickelée	15 mm	40 mm	3 mm	30 mm	1 pièce

**Vis pour Embase frontal**

N° de com.	Description	Diamètre	Longueur	Unité de com.
003531	PZ2	M4	12 mm	1 pièce

## INSERT

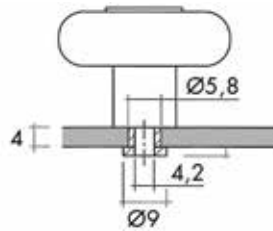
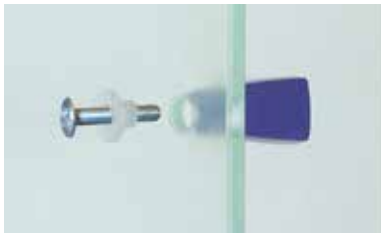
**Insert type D6**

Protège une porte glace au montage d'un bouton ou d'une poignée.

N° de com.	Finition	pour verre de	Unité de com.
013156	transparent	4 mm	1 pièce

VIS

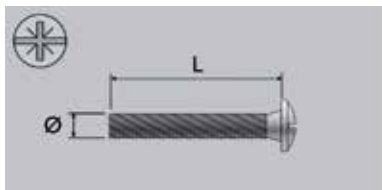

**Vis type M4**

- vis pour boutons et poignées
- pozidrive

N° de com.	Finition	Diamètre	Longueur	Unité de com.
052269	zingué	4 mm	10 mm	1 pièce
052271	zingué	4 mm	15 mm	1 pièce
052273	zingué	4 mm	20 mm	1 pièce
052274	zingué	4 mm	21 mm	1 pièce
052275	zingué	4 mm	22 mm	1 pièce
052276	zingué	4 mm	23 mm	1 pièce
052277	zingué	4 mm	25 mm	1 pièce
052278	zingué	4 mm	28 mm	1 pièce
052279	zingué	4 mm	30 mm	1 pièce
052280	zingué	4 mm	35 mm	1 pièce
054506	zingué	4 mm	38 mm	1 pièce
052282	zingué	4 mm	40 mm	1 pièce
052284	zingué	45 mm	45 mm	1 pièce
003487	zingué	4 mm	50 mm	1 pièce
003499	zingué	4 mm	60 mm	1 pièce

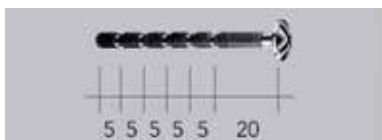

**Vis type M4 autocassante**

- autocassante par 5 mm

N° de com.	Finition	Longueur	Longueur minimum	Détachable	Unité de com.
059171	zingué	45 mm	20 mm	5 mm	1 pièce

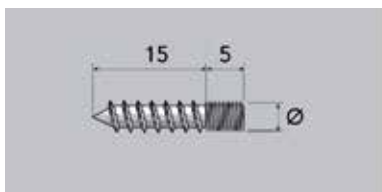

**Broche type M4**

- broche pour boutons et poignées

N° de com.	Finition	diamètre	Unité de com.
003490	nickelé	4 mm	1 pièce

**Van Opstal & C° s.a.**  
**Boomsesteenweg 34, B- 2630 Aartselaar**  
T +32 (0)3- 887.40.48 • F +32 (0)3- 887.76.06 • E info@vanopstal.be  
www.vanopstal.be

Sous réserve de modifications techniques.  
Sauf erreurs et omissions.

Votre revendeur: